



photoFlex[®] pH Handheld colorimeter



a xylem brand



For the most recent version of the manual, please visit www.yisi.com.

Contact

YSI
1725 Brannum Lane
Yellow Springs, OH 45387 USA
Tel: +1 937-767-7241
800-765-4974
Email: environmental@ysi.com
Internet: www.yisi.com

Copyright

© 2013 Xylem Inc.

pHotoFlex® pH - Contents

1	Overview	7
1.1	General features	7
1.2	Keypad	8
1.3	Display	10
1.4	Socket field	10
1.5	LabStation (optional)	10
2	Safety	13
2.1	Safety information	13
2.1.1	Safety information in the operating manual	13
2.1.2	Safety signs on the meter	13
2.1.3	Further documents providing safety information	13
2.2	Safe operation	14
2.2.1	Authorized use	14
2.2.2	Requirements for safe operation	14
2.2.3	Unauthorized use	14
3	Commissioning	15
3.1	Scope of delivery	15
3.2	Power supply	15
3.2.1	General information	15
3.2.2	Inserting/exchanging the batteries	17
3.3	Initial commissioning	18
4	Operation	19
4.1	Switching on the meter	19
4.2	Inserting a cell	20
4.3	General operating principles	22
4.3.1	Operating modes	22
4.3.2	Navigation	22
4.3.3	Navigation example 1: Setting the language	24
4.3.4	Navigation example 2: Setting the date and time	25
4.3.5	Menu overview	28
4.4	System settings (<i>System</i> menu)	30
4.4.1	<i>Measured value memory</i>	31
4.4.2	<i>Display</i>	33
4.4.3	<i>Interface</i>	33
4.4.4	<i>Date/time</i>	34
4.5	Photometry	35
4.5.1	General information	35
4.5.2	Settings for photometric measurements	36

4.5.3	Measuring the concentration	37
4.5.4	Blank value (reagent blank value)	38
4.5.5	Standard adjustment (user calibration)	41
4.5.6	Measuring the absorbance/transmission	43
4.5.7	Zero adjustment	44
4.5.8	Programs	46
4.5.9	<i>Analysis timer</i>	47
4.5.10	<i>Timer</i>	47
4.5.11	Measuring diluted samples	48
4.6	pH value / ORP voltage	49
4.6.1	General information	49
4.6.2	Measuring the pH value	50
4.6.3	Measuring the ORP voltage	51
4.6.4	Settings for pH and ORP measurements	51
4.6.5	Calibration	53
4.6.6	Carrying out the TEC and NIST/DIN calibration procedures	56
4.7	Storing	60
4.7.1	Storing measurement datasets	61
4.7.2	Filtering measurement datasets	62
4.7.3	Displaying measurement datasets	63
4.7.4	Downloading the measurement datasets to the RS232 interface	63
4.7.5	Erasing stored measurement datasets	64
4.8	Transmitting data (RS 232 interface)	64
4.8.1	Connecting a PC	64
4.8.2	Configuring the RS232 interface	65
4.8.3	Selecting the output format of datasets	65
4.8.4	Transmitting data	67
4.9	Reset	68
4.9.1	Resetting the system settings	68
4.9.2	Resetting the photometry settings	69
4.9.3	Resetting the pH settings	69
4.10	Meter information	70
4.11	Software update	70
4.12	Administrating user-defined methods	71
4.12.1	Administrating user-defined programs with a terminal program	72
5	Maintenance, cleaning, disposal	77
5.1	Maintenance	77
5.1.1	Inserting/exchanging the batteries	77
5.1.2	Retrofitting the rechargeable battery	78
5.2	Cleaning	79
5.2.1	Cleaning the cell shaft	79
5.2.2	Cleaning the cells	80

5.3	Packing	80
5.4	Disposal	80
6	What to do if...	81
6.1	General errors	81
6.2	Photometry	82
6.3	pH value / ORP voltage	82
7	Technical data	85
7.1	General data	85
7.2	Photometry	87
7.3	pH value / ORP voltage	88
8	Accessories, options	89
8.1	Accessories	89
8.1.1	Connection cable	89
8.2	Optional extensions of the pHotoFlex® pH	89
9	Lists	91
10	Index	97
11	Firmware update	99
12	Contact Information	101
12.1	Ordering & Technical Support	101
12.2	Service Information	101

1 Overview

1.1 General features

The compact pHotoFlex® pH handheld precision meter enables you to carry out the following measurements quickly and reliably:

- Photometric measurements
 - Concentration measurements (colorimetric measurements)
 - Absorbance measurements
 - Transmission measurements
- pH measurements.

The pHotoFlex® pH handheld meter provides the maximum degree of operating comfort, reliability and measuring certainty for all applications.

The proven MultiCal® calibration procedure supports you when calibrating for pH measurements and the AutoRead function enables precise pH measurements.

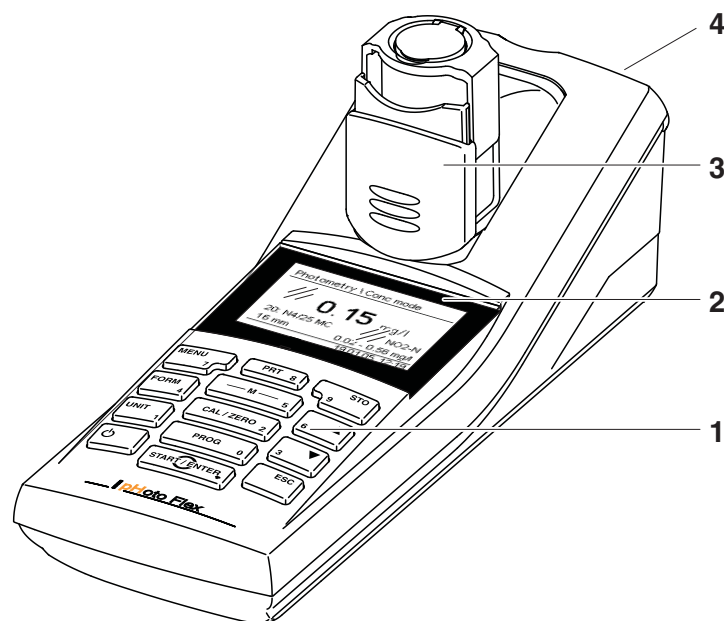





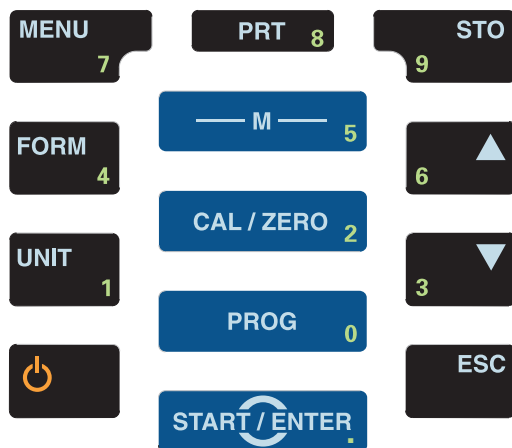







1	Keypad
2	Display
3	Cell shaft (folded out for a 16 mm cell to be inserted)
4	Socket field

1.2 Keypad



Key functions

	<p>Select the measuring mode <M> (long keystroke):</p> <ul style="list-style-type: none"> – Photometry – pH & ORP <p>Select the measured parameter within a measuring mode <M> (short keystroke):</p> <ul style="list-style-type: none"> – pH & ORP: pH, ORP – Photometry: Concentration, Absorbance, % Transmission
	<p>Start calibration (measuring mode pH & ORP) Start zero adjustment or blank value measurement using the <i>Photometry \ Adjustment</i> menu (measuring mode, <i>Photometry</i>) <CAL/ZERO></p>
	<p>In the <i>Photometry</i> measuring mode: Select a program for concentration measurement <PROG></p>
	<p>Open menus / confirm entries / start measurement <START/ENTER></p>
	<p>Call up the <i>Configuration</i> menu (all settings are made here) <MENU></p>

	In the <i>Photometry</i> measuring mode, measured parameter, <i>Concentration</i> : switch over between available citation forms <FORM>
	In the <i>Photometry</i> measuring mode, measured parameter, <i>Concentration</i> : Switch over between available units <UNIT>
	Switch the measuring instrument on/off <ON/OFF>
	Output display contents to RS232 interface <PRT>
	Open the <i>Store</i> menu <STO>, Quick storing <STO> <STO>
 	Highlight menu items or selection Set values <▲>, <▼>
	Switch to the next higher menu level / cancel input <ESC>



Keys with an additional number printed on are assigned doubly. This enables to directly enter numbers in special menus. Thus, you can, for example, conveniently enter the date and time via the number keys.

1.3 Display

The graphic display shows all information of the current measurement in the measured value display. The illumination enables to read the display even in the darkness.

Example

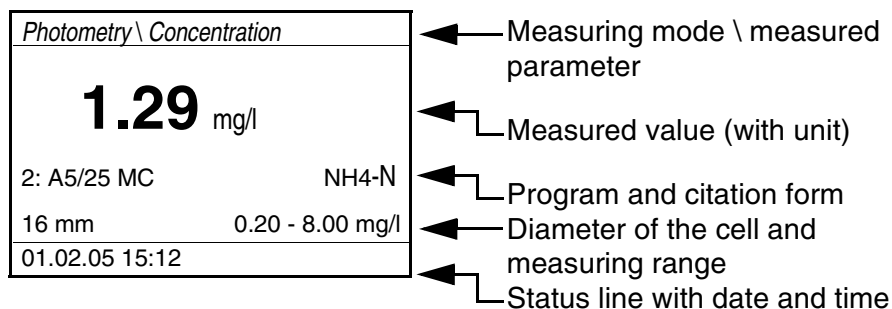

1.4 Socket field

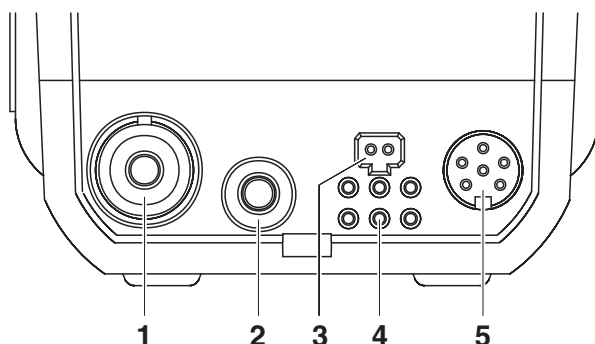

Identifying the connectors

1	pH electrode
2	pH temperature sensor
3	Power pack (9 V DC, see section 7.1)
4	Contacts for operation on the LabStation
5	RS232 serial interface

1.5 LabStation (optional)

The LabStation, which is available as an accessory, enables you to use the pHotoFlex® pH conveniently in the laboratory (see LabStation operating manual).

Laboratory operation with the LabStation enables the following additional functions:

- With photometric measurements, the zero measurement is retained even after switching the pHotoFlex® pH off and on again
- You can connect a bar code reader for the simplified calling up of programs
- The LSdata software included serves to easily enter user-defined programs
- Operation with power pack and rechargeable battery (included in the scope of delivery of the LabStation). The rechargeable battery in the pHotoFlex® pH is automatically charged as soon as the meter is placed in the LabStation.

2 Safety

2.1 Safety information

2.1.1 Safety information in the operating manual

This operating manual provides important information on the safe operation of the meter. Read this operating manual thoroughly and make yourself familiar with the meter before putting it into operation or working with it. The operating manual must be kept in the vicinity of the meter so you can always find the information you need.

Important safety instructions are highlighted in this operating manual. They are indicated by the warning symbol (triangle) in the left column. The signal word (e.g. "Caution") indicates the level of danger:



CAUTION

indicates a possibly dangerous situation that can lead to slight (reversible) injury if the safety instruction is not followed.

NOTE

indicates a possibly dangerous situation where goods might be damaged if the actions mentioned are not taken.

2.1.2 Safety signs on the meter

Note all labels, information signs and safety symbols on the meter and in the battery compartment. A warning symbol (triangle) without text refers to safety information in this operating manual.

2.1.3 Further documents providing safety information

Observe the safety datasheets of the test reagents when working with photometric test sets.

2.2 Safe operation



CAUTION

Danger of eye damage by visible and invisible LED radiation. In the cell shaft there are light emitting diodes (LED) of the 1M class. Do not look at the radiation using optical instruments. With normal, authorized use there is no hazard.

2.2.1 Authorized use

This meter is authorized exclusively for the following measurements:

- Analysis of substances in water and aqueous solutions using round cells
- Concentration measurement
- Absorbance and transmission measurement

The fields of application are mobile use and use in the laboratory. Only the operation and running of the meter according to the instructions and technical specifications given in this operating manual is authorized (see chapter 7 TECHNICAL DATA). Any other use is considered unauthorized.

2.2.2 Requirements for safe operation

Note the following points for safe operation:

- The meter may only be operated according to the authorized use specified above.
- The meter may only be supplied with power by the energy sources mentioned in this operating manual.
- The meter may only be operated under the environmental conditions mentioned in this operating manual.
- The meter may only be opened if this is explicitly described in this operating manual (example: Inserting the batteries).

2.2.3 Unauthorized use

The meter must not be put into operation if:

- it is visibly damaged (e.g. after being transported)
- it was stored under adverse conditions for a lengthy period of time (storing conditions, see chapter 7 TECHNICAL DATA).

3 Commissioning

3.1 Scope of delivery

- Handheld meter, pHotoFlex® pH
- 4 batteries, 1.5 V type AA (in the battery compartment)
- 1 empty cell 16 mm
- 2 empty cells 28 mm
- Microfiber cloth to clean the meter
- Quick start guide English
- Key overview / Program list
- CD-ROM with
 - detailed operating manual
 - photometry analysis manual with analysis specifications
 - software to program user-defined methods
- Optional: Rechargeable battery
- Optional: LabStation with LSdata PC software, rechargeable battery and universal power pack



The optional parts of the scope of delivery are available as accessories (see section 8.1).

3.2 Power supply

3.2.1 General information

You can operate the meter either with batteries, rechargeable batteries or a power pack. The power pack supplies the meter with low voltage (9 V DC). At the same time, the rechargeable battery is charged. The rechargeable battery is charged even while the meter is switched off.

The *LoBat* display indicator appears when the batteries or rechargeable batteries is nearly discharged.

approx. 36 hours.

Charging time of the rechargeable battery



CAUTION

Use original power packs only.

The line voltage at the operating site must lie within the input voltage range of the original power pack (see chapter 7 TECHNICAL DATA).



The rechargeable battery should not be completely discharged. If you do not operate the instrument for a longer period of time you should charge the rechargeable battery every six months.

Automatic switchoff

The meter has an automatic switch-off function in order to save the batteries or rechargeable battery (see section 4.4).

Display illumination

During operation with batteries or rechargeable battery the meter automatically switches off the display illumination if no key is pressed for 30 seconds. The illumination is switched on with the next keystroke again. The display illumination can also be switched off completely (see section 4.4.2).

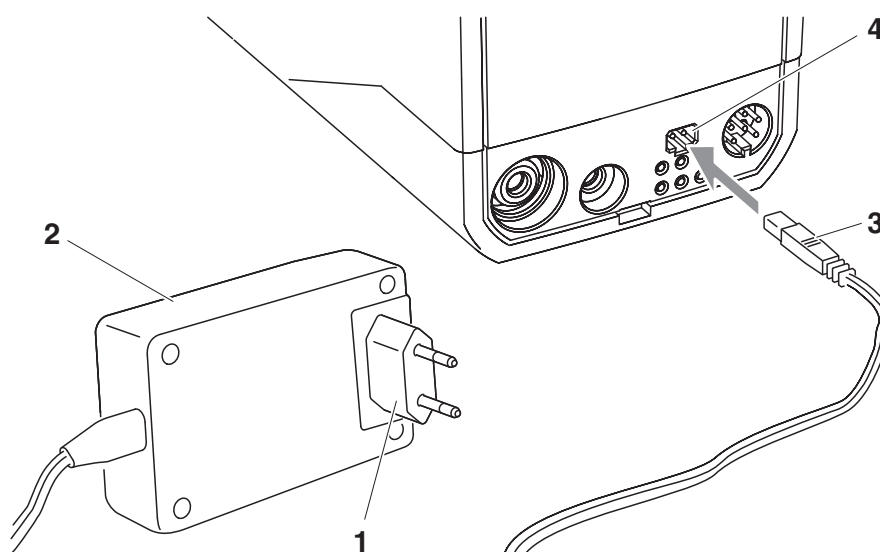

Power pack and rechargeable battery are available as an accessory (see section 8.1).

Connecting the power pack (optional)

- | | |
|---|---|
| 1 | If necessary, replace the Euro plug (1) on the power pack (2) by the country-specific plug suitable for your country. |
| 2 | Connect the plug (3) to the socket (4) of the meter. |
| 3 | Connect the power pack to an easily accessible power socket. |

3.2.2 Inserting/exchanging the batteries

NOTE

Make sure that the poles of the batteries are positioned correctly. The ± signs on the batteries must correspond to the ± signs in the battery compartment.

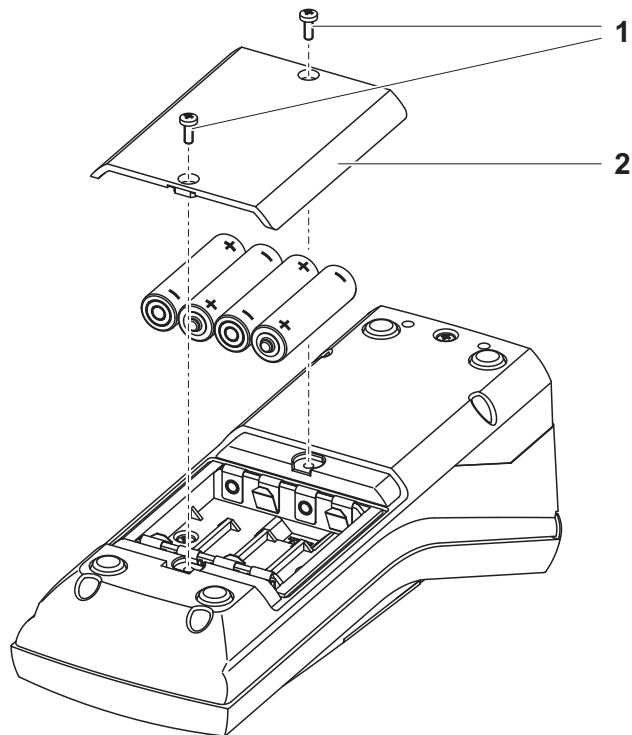

- | | |
|---|--|
| 1 | Open the battery compartment: <ul style="list-style-type: none">– Unscrew the two screws (1) on the underside of the meter,– Remove the lid of the battery compartment (2). |
| 2 | If necessary, take four old batteries out of the battery compartment. |
| 3 | Insert four batteries (3) in the battery compartment. |
| 4 | Close the battery compartment and fix it with the screws. |

3.3 Initial commissioning

Perform the following activities:

- For
 - Battery operation: Insert the batteries (see section 3.2.2)
 - Rechargeable battery operation: insert the rechargeable battery (see section 5.1.2)
 - line power operation and charging the rechargeable battery: connect the power pack (see section 3.2)
 - Operation with LabStation and rechargeable battery: Insert the rechargeable battery, connect the LabStation and insert the meter in the LabStation (see LabStation operating manual)
- Switch on the meter (see section 4.1)
- Set the language as necessary (see section 4.3.3)
- Set the date and time as necessary (see section 4.3.4)



When you set the language, date and time according to the mentioned sections of this operating manual you will quickly become familiar with the simple operation of the pHotoFlex® pH.

4 Operation

4.1 Switching on the meter

Switching on

Press the **<ON/OFF>** key.

For 30 seconds, *Start* menu appears with a selection of the measuring modes. The measuring mode last selected is highlighted.

The status line indicates the meter designation and the version number of the software.

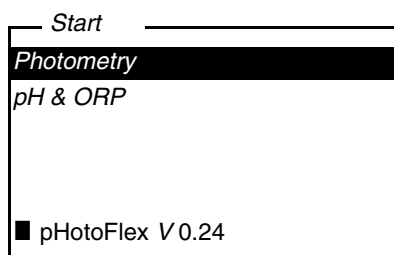

After a few seconds, the meter automatically switches to the measuring mode and measured parameter used last.

The measured value display appears (here, e.g. measuring mode *Photometry*).

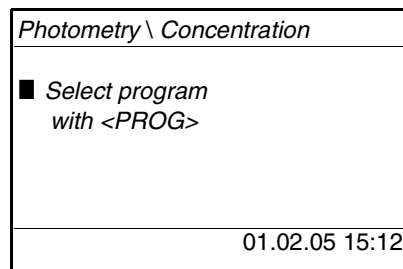

With **<M>** (long pressure) change the measuring mode.

With **<M>** (short pressure) toggle between the different measured parameters in the selected measuring mode.

Switching off

Press the **<ON/OFF>** key.

Automatic switchoff

The meter has an automatic switchoff function in order to save the batteries or rechargeable battery (see section 4.4). The automatic switchoff switches the meter off if no key is pressed for an adjustable period.

The automatic switchoff is not active

- if the power is supplied by the power pack (optional),
- if the power is supplied by the LabStation (optional),
- if the *Timer* or *Analysis timer* function is on.

Display illumination with battery and rechargeable battery operation

During operation with batteries or rechargeable battery the meter automatically switches off the display illumination if no key is pressed for 30 seconds. The illumination is switched on again with the next key-stroke.

4.2 Inserting a cell

To be able to insert cells in the pHotoFlex® pH, the cell shaft has to be prepared to take in a cell.

- 1 Push the dust cover (1) upward.
The cell shaft for 28 mm cells is open.
 - Insert a 28 mm cell (see below)
 - Insert a 16 mm cell (see page 20)

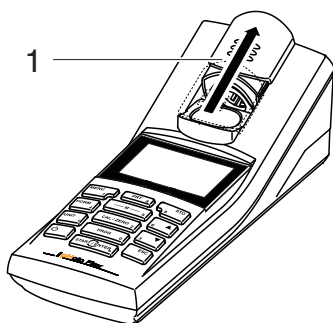

Inserting a 28 mm cell

- 2 Insert the cell so that it is positioned on the bottom of the cell shaft.
The cell is ready to be measured.



Inserting a 16 mm cell

- 1 Put the fold-out cell shaft (2) in an upright position until it locks into place.

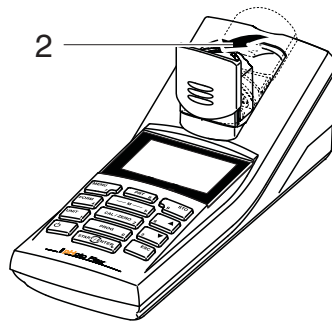

- 2 Pull up the height adapter (3).
The cell shaft is extended.

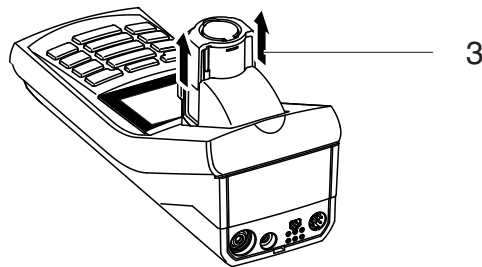

- 3 Open the external light cover (4) of the cell shaft.

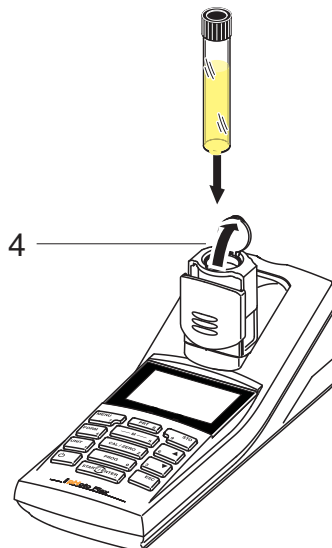

- 4 Insert the 16 mm cell (marking points forward) so that it is positioned on the bottom of the cell shaft.
- 5 Close the external light cover (4).
The cell is ready to be measured.



For optimum measurement results, the cell must always be covered by the external light cover. Otherwise, external light can falsify the measurement result.

4.3 General operating principles

This section contains basic information on the operation of the pHotoFlex® pH.

Operating elements, display

An overview of the operating elements and the display is given in section 1.2 and section 1.3.

Operating modes, navigation

An overview of the operating modes of the pHotoFlex® pH and the navigation through menus and functions can be found in section 4.3.1 and section 4.3.2.

4.3.1 Operating modes

The instrument has the following operating modes:

- Measurement
The display indicates measurement data in the measured value display
- Calibration
The display indicates a calibration process with calibration information, or a process to carry out a zero adjustment
- Data transmission
The meter transmits measuring datasets or calibration records to the serial interface
- Configuration
The display indicates a menu with further menus, settings and functions

4.3.2 Navigation

Measured value display

In the measured value display, you can

- select a measuring mode with **<M>** (long pressure)
- select a measured parameter in the active measuring mode (e. g. pH <-> mV) with **<M>** (short pressure)
- open the menu with **<MENU>**
- switch to the superordinate *Start* menu with **<ESC>**.

Menus and dialogs

The menus for settings and dialogs in courses contain further sub-menus. The selection is made with the <▲> <▼> keys. The current selection is highlighted as white text on a black background.

- **Menus**

The name of the menu is displayed at the upper edge of the frame. Menus are opened by confirming with <START/ENTER>. Example:

Configuration	
Photometry	
pH & ORP	
System	
Info	

- **Settings**

Settings are indicated by a colon. The current setting is displayed on the right-hand side. With <START/ENTER>, the selection of the possible settings is opened. Subsequently, the setting can be changed with <▲> <▼> and <START/ENTER>.

Example:

System	
Language:	English
Beep:	Off
Illumination:	On
Contrast:	48 %
Temperature unit:	°C
Switchoff time:	30 min

- **Functions**

Functions are designated by the name of the function. They are immediately carried out by confirming with <START/ENTER>.

Example: display the *Calibration record* function (in the *pH & ORP / Calibration* menu).

pH & ORP	
Calibration record	
Cal. type:	AutoCal
TEC	
Calibration interval:	007 d
Unit for slope:	mV/pH
■ 2.00 4.01 7.00 10.01	

- Messages

Information or instructions are marked by the ■ symbol. They cannot be selected.

Example:

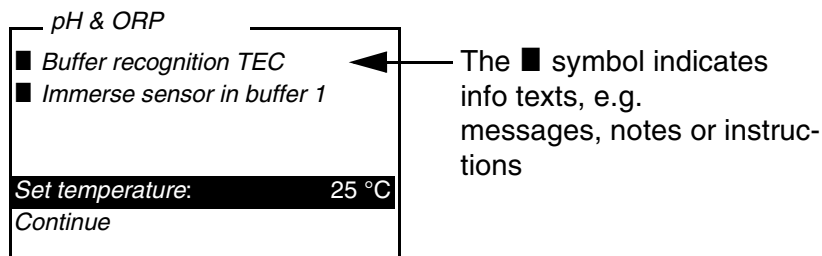

The principles of navigation are explained in the two following sections by reference of examples:

- Setting the language (section 4.3.3)
- Setting the date and time (section 4.3.4).

4.3.3 Navigation example 1: Setting the language



The following example describes in the language of the country how to set the language. On delivery, English is set as the language in the pHotoFlex® pH. During initial commissioning, the language is set in the menu, *Configuration / System / Language*.

1	In the measured value display: Open the <i>Configuration</i> menu with <MENU>. The instrument is in the configuration mode.
2	Select the <i>System</i> menu with <▲> <▼>. The current selection is highlighted as white text on a black background.
3	Open the <i>System</i> menu with <START/ENTER>.

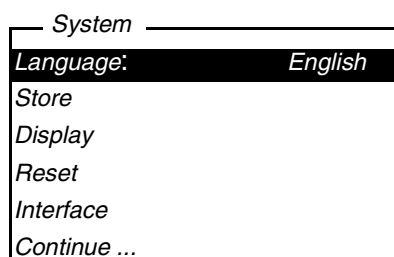

4	Select the <i>Language</i> menu with <▲> <▼>. The current selection is highlighted as white text on a black background.
5	Open the setting of the <i>Language</i> with <START/ENTER>.

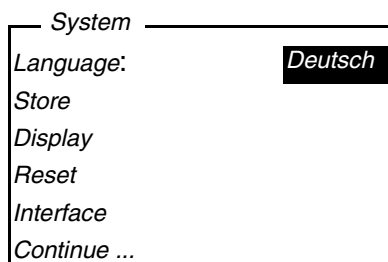

6	Select the required language with <▲> <▼>.
7	Confirm the setting with <START/ENTER>. The setting is active. The menu is displayed in the selected language.
8	To make further settings, switch to the next higher menu level with <ESC>. or Switch to the measured value display with <M> (short pressure). The instrument is in the measurement mode.

4.3.4 Navigation example 2: Setting the date and time

The meter has a clock with a date function. The date and time are indicated in the status line of the measured value display. When storing measured values and calibrating, the current date and time are automatically stored as well.

Numerals are generally entered via the number keys.

The correct setting of the date and time and date format is important for the following functions and displays:

- Current date and time
- Calibration date
- Identification of stored measured values.

Therefore, check the time at regular intervals.



Setting the date, time and date format

After a fall of the supply voltage (empty batteries or rechargeable battery), the date and time are reset to 01.01.2003, 00:00 hours.

The data format can be switched from the display of day, month, year (*dd.mm.yy*) to the display of month, day, year (*mm/dd/yy* or *mm.dd.yy*).

- 1 In the measured value display:
Open the *Configuration* menu with **<MENU>**.
The instrument is in the configuration mode.
- 2 Select and confirm the *System / Continue ... / Date/time* menu with **<▲>** **<▼>** and **<START/ENTER>**.

Date/time	
Time:	14:53:40
Date:	30.10.03
Date format:	dd.mm.yy

- 3 Select and confirm the *Time* menu with **<▲>** **<▼>** and **<START/ENTER>**.
A display for the entry of numerals with the number keys opens up.

Time	
<u>14</u> :53:40	

- 4 Enter the time using the number keys.
The digit to be changed is displayed underlined.



In the case of wrong entries, you can cancel the procedure with **<ESC>.**

After canceling with **<ESC>, it is possible to enter all digits once again. The new digits are only taken over by confirming with **<START/ENTER>**.**

- 5 Confirm the setting with **<START/ENTER>**.
The time is set.

6	Set the current <i>Date</i> as necessary. The setting is made similarly to that of the time.
7	Change the date format as necessary.
8	To make further settings, switch to the next higher menu level with <ESC> . or Switch to the measured value display with <M> (short pressure). The instrument is in the measurement mode.

4.3.5 Menu overview

<i>Photometry</i>	<i>Measured parameter</i>	<i>Concentration</i> <i>% Transmission</i> <i>Absorbance</i>		
	<i>Programs</i>			
	<i>Dilution</i>			
	<i>Analysis timer</i>	<i>On</i> <i>Off</i>		
	<i>Reset</i>			
<i>pH & ORP</i>	<i>Measured parameter</i>	<i>pH</i> <i>ORP</i>		
	<i>Calibration</i>	<i>Calibration re- cord</i>		
		<i>Cal. type</i>	<i>TEC</i> <i>NIST/DIN</i>	
		<i>Calibration inter- val</i>	1 ... 999 d	
		<i>Unit for slope</i>	mV/pH %	
	<i>Man. temperature</i>	-20 ... +130 °C		
	<i>Temperature unit</i>	°C, °F		
<i>Reset</i>				
<i>Timer</i>				

(Continued next page)

<i>System</i>	<i>Language</i>	<i>Deutsch</i> <i>English</i> <i>Français</i> <i>Español</i>		
	<i>Measured value memory</i>	<i>Display</i>		
		<i>RS232 download</i>		
		<i>Data filter</i>	<i>Filter ID</i> <i>PROG</i> <i>Date</i>	
		<i>Delete</i>		
		■ <i>4 of 1000 occupied</i>		
		■ <i>Filter: No filter</i>		
	<i>Display</i>	<i>Illumination</i>	<i>Auto off</i> <i>On</i> <i>Off</i>	
		<i>Contrast</i>	0 ... 100 %	
		<i>Brightness</i>	0 ... 100 %	
	<i>Reset</i>			
	<i>Interface</i>	<i>Baud rate</i>	1200, 2400, 4800, 9600, 19200	
		<i>Output format</i>	<i>ASCII</i> <i>CSV</i>	
	<i>Continue ... / Date/time</i>	<i>Time</i>	hh:mm:ss	
		<i>Date</i>		
<i>Date format</i>		<i>dd.mm.yy</i> <i>mm.dd.yy</i> <i>mm/dd/yy</i>		
<i>Continue ... / Switchoff time</i>	10, 20, 30, 40, 50 min, 1, 2, 3, 4, 5, 10, 15, 20, 24 h			
<i>Continue ... / Beep</i>	<i>On</i> <i>Off</i>			

Info

4.4 System settings (System menu)

The following instrument features and general functions can be found in the *Configuration / System* menu:

- Language selection (*Language*)
- Memory and database functions (*Store*)
- Display settings (*Display*)
- Restore basic settings (*Reset*)
- Configuration of the interface for PC (*Interface*)
- Setting the date/time (*Date/time*)
- Setting the switch-off time (*Switchoff time*)
- Setting the keyboard sound (*Beep*)

Settings/functions

The settings can be found in the *Configuration / System* menu. To switch to the *Configuration* menu, press the <MENU> key.

Menu item	Setting	Description
<i>Language</i>	<i>Deutsch</i> <i>English</i> <i>Français</i> <i>Español</i>	Select the language (see section 4.3.3)
<i>Store</i>	<i>Display</i> <i>RS232 down- load</i> <i>Data filter</i> <i>Delete</i>	Memory and database functions (see section 4.7.2)
<i>Display</i>	<i>Illumination</i> <i>Contrast</i> <i>Brightness</i>	Switch on/off the display illumination (see section 4.4.2)
<i>Reset</i>	-	Resets all system settings to default (see section 4.9.1)
<i>Interface</i>	<i>Baud rate</i> <i>Output format</i>	Baud rate of the data interface (see section 4.4.3)
<i>Continue ... / Date/time</i>	<i>Time</i> <i>Date</i> <i>Date format</i>	Settings of time and date (see section 4.3.4)

Menu item	Setting	Description
<i>Continue ... / Switchoff time</i>	10, 20, 30, 40, 50 min, 1, 2, 3, 4, 5, 10, 15, 20, 24 h	The automatic switchoff switches the meter off if no entry is made for a specified period of time (<i>Switchoff time</i>). This saves the batteries or rechargeable battery.
<i>Continue ... / Beep</i>	<i>On</i> <i>Off</i>	Switch on/off the beep on keystroke

4.4.1 *Measured value memory*

In the *Measured value memory* menu, you find functions to display and edit the stored measurement datasets:

- Display the measurement datasets on the screen (*Display*)
- Download the measurement datasets to the RS232 interface (*RS232 download*)
- Set up filter rules for the stored measurement datasets (*Data filter*)
- Erase all stored measurement datasets (*Delete*)
- Information on the number of occupied memory locations

The settings can be found in the *Configuration / System / Measured value memory* menu.

To switch to the *Configuration* menu, press the **<MENU>** key.

Settings/functions	Menu item	Setting/function	Description
	<i>Display</i>	-	<p>Displays in pages all measurement datasets that correspond to the filter settings.</p> <p>Further options:</p> <ul style="list-style-type: none"> ● Scroll through the datasets with <▲> <▼>. ● Output the displayed dataset to the interface with <PRT>. ● Quit the display with <ESC>.
	<i>RS232 download</i>	-	<p>Downloads to the interface all measurement datasets that correspond to the filter settings. The download is ordered according to the date and time.</p> <p>The process can take several minutes. To terminate the process prematurely, press <ESC>.</p>
	<i>Data filter</i>	see section 4.7.2	Allows to set filter criteria in order to display and download datasets to the interface.
	<i>Delete</i>	-	<p>Erases the entire contents of the measuring data memory, independent of the filter settings.</p> <p>Note: All calibration data remains stored when performing this action.</p>

All details on the subjects of memory and stored data is found in section 4.7.2.

4.4.2 Display

In the *Configuration / System / Display* menu, you set the display features:

- Switching on/off the display illumination (*Illumination*)
- Display contrast (*Contrast*)

The settings can be found in the *Configuration / System / Display* menu. To switch to the *Configuration* menu, press the **<MENU>** key.

Settings	Menu item	Setting	Description
	<i>Illumination</i>	<i>Auto off</i>	The display illumination is automatically switched off if no key has been pressed for 30 seconds.
		<i>On</i> <i>Off</i>	Switches the display illumination on or off permanently (see section 4.5.9)
	<i>Contrast</i>	0 ... 100 %	Changes the display contrast
	<i>Brightness</i>	0 ... 100 %	Changes the display brightness

4.4.3 Interface

In the *Interface* menu, you set the features of the interface:

- Transmission speed (*Baud rate*)
- Output format (*Output format*)

The settings can be found in the *Configuration / System / Interface* menu.

To switch to the *Configuration* menu, press the **<MENU>** key.

Settings	Menu item	Setting	Description
	<i>Baud rate</i>	1200, 2400, 4800, 9600, 19200	Baud rate of the data interface
	<i>Output format</i>	<i>ASCII</i> <i>CSV</i>	Output format for data transmission For details, see section 4.8

4.4.4 Date/time

In the *Configuration / System / Continue ... / Date/time* menu, you set the system clock:

- Current time (*Time*)
- Current date (*Date*)
- Format of the date display (*Date format*)

The settings can be found in the *Configuration / System / Continue ... / Date/time* menu.

To switch to the *Configuration* menu, press the <MENU> key.

Settings

Menu item	Setting	Description
<i>Time</i>	hh:mm:ss	Enter the time with the number keys
<i>Date</i>		Enter the date with the number keys
<i>Date format</i>	<i>dd.mm.yy</i> <i>mm.dd.yy</i> <i>mm/dd/yy</i>	Settings of time and date.

4.5 Photometry

4.5.1 General information

Photometric measurements serve to determine chemical substances in liquid samples. For this determination, the substance to be determined has to be present in a form that is suitable for photometric measurement. At the same time, possible disturbing factors have to be excluded.

Before measurement, the sample has to be pretreated in order to bring the substance to be determined into the form that is suitable for measurement and at the same time exclude disturbing factors. Pretreatment of the sample is described in the analysis specification.

In a simple case, pretreatment can be to dissolve a solid substance in water; it can, however, also include chemical conversions, e. g. a digestion.

The chemicals required in the analysis specification are available as test sets.

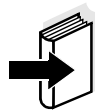

Suitable analysis specifications for test sets can be found in the photometry analysis manual (on CD-ROM).

There you will also find further instructions on handling chemicals and on how to proceed when applying the analysis specifications.

Methods and the corresponding method data for many test sets are stored as programs in the pHotoFlex® pH. A program number is assigned to each program.

By entering the program number or by using a barcode reader the stored method data is loaded.

You can look up an overview of the available methods in the photometry analysis manual and display it on the screen of the pHotoFlex® pH (see section 4.5.8).

You can measure the following parameters with the pHotoFlex® pH:

- *Concentration* [mg/l]
- *% Transmission* []
- *Absorbance* []

Preparatory activities

Perform the following preparatory activities when you want to measure:

1	Clean the cells before filling them with sample and also before measuring as necessary (see section 5.2.2). The cells must be absolutely clean and free of scratches.
2	For measurement, place the pHotoFlex® pH on a horizontal surface.

4.5.2 Settings for photometric measurements

For photometric measurements, the following settings are available in the *Configuration / Photometry* menu:

- Setting the measured parameter
- Displaying a list of all programs
- Setting the dilution factor
- Switching on or off the analysis timer
- Resetting the settings for photometric measurements

The settings can be found in the *Configuration / Photometry* menu. To switch to the *Configuration* menu, press the <MENU> key.

Settings

Menu item	Setting	Description
<i>Measured parameter</i>	<i>Concentration</i> <i>% Transmission</i> <i>Absorbance</i>	Measured parameters in the <i>Photometry</i> measuring mode
<i>Programs</i>		Display all programs with the corresponding program data (see section 4.5.8).
<i>Dilution</i>		Set the dilution factor (see section 4.5.11)
<i>Analysis timer</i>	<i>On</i> <i>Off</i>	Switch on/off the analysis timer (see section 4.5.9)
<i>Reset</i>		Reset all settings for the <i>Photometry</i> measuring mode (see section 4.9.3)

4.5.3 Measuring the concentration

- | | |
|---|---|
| 1 | Press the <M> key (long pressure) repeatedly until the <i>Photometry</i> measuring mode is selected. |
| 2 | Press the <M> key (short pressure) repeatedly until the measured variable, <i>Konzentration</i> is selected. |

First concentration measurement with the pHotoFlex® pH

Photometry \ Concentration	
■ Select program with <PROG>	
	01.02.05 15:12

Second and all further concentration measurements

Photometry \ Concentration	
■ Select program with <PROG> or with ▲ ▼	
1: A5/25 MC	NH4-N
16 mm	0.20 - 6.51 mg/l
	01.02.05 15:12



From the second concentration measurement, the data of the program last used is automatically displayed here.

With **<▲>** **<▼>** you can quickly switch between the ten programs last used.

To select a program, you can also read in the program number of an analysis specification with a barcode reader (see section 8.2). The following step 3 is then skipped. You can directly start measurement.

The program number of the test is given in the analysis specification, on the list of available programs and on the packing of some tests (under the barcode).

- | | |
|---|---|
| 3 | Open the <i>Program number</i> display with <PROG> , enter the required program number with the number keys and confirm with <START/ENTER> .
or (from the second concentration measurement):
Select a program out of the last ten programs with <▲> <▼> .
The program data is displayed. |
|---|---|



If a program number is selected that requires a measured blank value, the menu automatically guides to the blank value measurement.

Photometry \ Concentration	
■ Insert sample	
■ Start measurement with <START>	
1: A5/25 MC	NH4-N
16 mm	0.20 - 6.51 mg/l
01.02.05 15:12	

- 4 | Insert the cell (see section 4.2).
- 5 | Start the measurement with <START/ENTER>. Measurement is started. The result is displayed.

Photometry \ Concentration	
[BV]	
0.74 mg/l	
1: A5/25 MC	NH4-N
16 mm	0.20 - 6.51 mg/l
01.02.05 15:12	

← A blank value measured by the user is used

4.5.4 Blank value (reagent blank value)

A blank value is required for every concentration measurement. For some programs (methods) for concentration measurement, the blank values are already stored in the meter. They are used automatically. For all other programs, the blank value has to be determined separately before the first measurement. Each stored reagent blank value can be replaced by a blank value determined by the user.



You will find more information on blank values in the photometry analysis manual.

A blank value is always stored for the program that has just been called up. It remains stored until it is erased (menu item, *Delete blank value*) or overwritten.

The *Reset* function erases all blank values measured by the user and restores the blank values stored in the factory.

If a blank value measured by the user is stored for a program, this blank value is used for measurement. The usage of the blank value measured by the user is documented and also indicated in the measured value display.

Measuring the blank value

- | | |
|---|---|
| 1 | Press the <M> key (long pressure) repeatedly until the <i>Photometry</i> measuring mode is selected. |
| 2 | Press the <M> key (short pressure) repeatedly until the measured variable, <i>Concentration</i> is selected. |
| 3 | Select a program with <PROG> as necessary. |



The following measurement of the blank value applies only to the selected program. If no program is selected, the message ■ *No program selected.* appears on the display.

- | | |
|---|---|
| 4 | Open the adjustment menu with <CAL/ZERO> . |
|---|---|

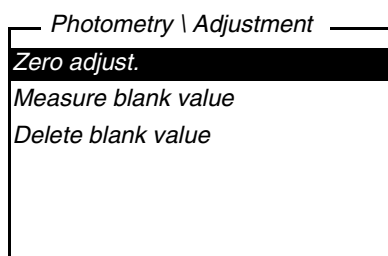

- | | |
|---|--|
| 5 | Using <▲> <▼> and <START/ENTER> , select and start the <i>Measure blank value</i> function.
The menu-guided blank value measurement starts.
Follow the instructions on the display. |
|---|--|

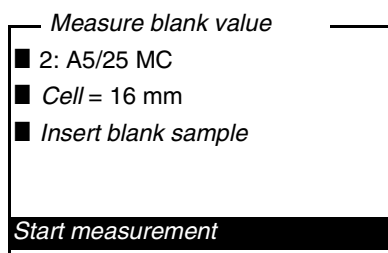

- | | |
|---|---|
| 6 | Insert a cell with blank sample (see section 4.2). |
| 7 | Start the measurement of the blank value with <START/ENTER> .
After measuring, the result of the blank value measurement is displayed and stored.
The result is displayed as ■ <i>Blank value measurement successful!</i> or ■ <i>Blank value measurement erroneous!</i> |

— *Measure blank value* —

- 2: A5/25 MC
- Cell = 16 mm
- Absorbance = 0.301
- Blank value measurement

successful!

- 8 Confirm the result with **<START/ENTER>**.
The blank value measurement is completed.
The meter is ready to measure.
or:
Discard the result with **<ESC>**.
Subsequently, carry out a new blank value measurement.

4.5.5 Standard adjustment (user calibration)

With some of the programs (methods) for concentration measurement, you can optimize the calibration curve stored in the meter with the aid of the *Standard adjustment* function.

A standard adjustment is only valid if the deviation compared to the original calibration is no more than 30%.

A standard adjustment is always stored for the program that is presently called up. A standard adjustment is only deleted if

- a new standard adjustment is carried out
- the standard adjustment is erased manually
- the meter is reset to delivery status (*Reset* function)

Standard adjustment

- | | |
|---|---|
| 1 | If necessary, press the <M> key several times until the measured parameter <i>Concentration</i> is selected. |
| 2 | Select a program with <PROG> as necessary. |



The following measurement of the standard applies only to the selected program.

- | | |
|---|---|
| 3 | Using <CAL/ZERO> , open the <i>Photometry \ Adjustment</i> menu. |
|---|---|

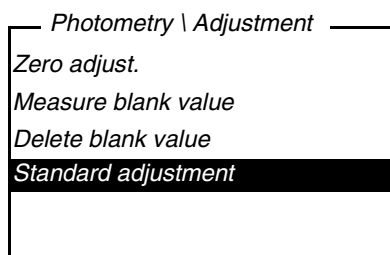

- | | |
|---|--|
| 4 | Open the <i>Standard adjustment</i> menu with <▲> <▼> and <START/ENTER> . |
|---|--|



If data of a standard adjustment are already available, the data of the last standard adjustment are displayed. Here you can also erase the data of an active standard adjustment.

- | | |
|---|--|
| 5 | Using <▲> <▼> and <START/ENTER> , select and start the <i>Measure standard</i> function.
The menu-guided standard measurement begins.
Follow the instructions on the display. |
|---|--|

Enter nominal value
mg/l Cu
—

- 6 Enter the nominal value of the standard.
Note:
Enter the decimal separator with <START/ENTER>.
- 7 Confirm the entered nominal value with <START/ENTER>.
- 8 Insert a cell with standard (see section 4.2).
- 9 Start the measurement of the standard with <START/ENTER>. After measuring, the result of the standard adjustment is displayed and stored. As the result, the measured value and the adjustment (in %) or *Error* is displayed.

Measure standard
■ 304: Cu-1 TP
Cell■ = 10 mm
■ 0.600 mg/l Cu:
2.000 (93.2%)
Accept

- 10 Confirm the result with <START/ENTER>. The standard adjustment is completed. The meter is ready to measure.
or:
Discard the result with <ESC>. Subsequently, carry out a new standard adjustment.



If a standard adjustment is stored for a program, the standard adjustment is automatically used for measurement. The usage of the standard adjustment is documented together with the measured value and indicated in the measured value display with [Cal].

4.5.6 Measuring the absorbance/transmission



The transmission measurement is not described separately in the following example as it operates in exactly the same way as the absorbance measurement. The result of the measurement is displayed in % *Transmission*.

- 1 Press the **<M>** key (long pressure) repeatedly until the *Photometry* measuring mode is selected.
- 2 Press the **<M>** key (short pressure) repeatedly until the measured variable, *Absorbance* or % *Transmission* is selected.

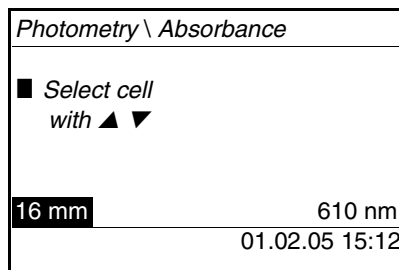

- 3 Select the cell diameter with **<▲>** **<▼>** and confirm with **<START/ENTER>**.
- 4 Select the wavelength with **<▲>** **<▼>** and confirm with **<START/ENTER>**.

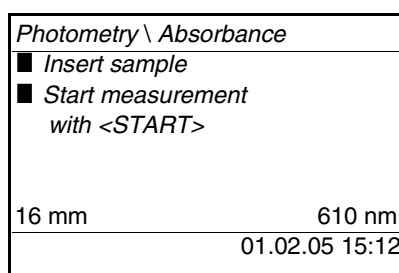

- 5 Clean the cell (see section 5.2.2).
- 6 Insert the cell (see section 4.2).
- 7 Start the measurement with **<START/ENTER>**.
The measurement result is displayed when the measurement is finished.

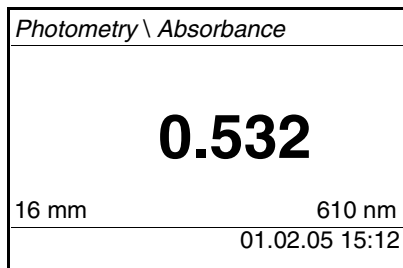

4.5.7 Zero adjustment

The zero adjustment, i. e. measuring and storing the absorbance of a cell filled with water, is necessary after the meter is switched on.

Additionally, we recommend to carry out a zero adjustment if the ambient temperature has changed.

Only perform the zero adjustment against distilled water in an optically perfect cell. The zero adjustment must be performed separately for each cell type.

1	Press the <M> key (long pressure) repeatedly until the <i>Photometry</i> measuring mode is selected.
2	Press the <M> key (short pressure) repeatedly until the measured variable, <i>Concentration</i> is selected.
3	Press the <CAL/ZERO> key. The menu for adjustment measurements opens up.

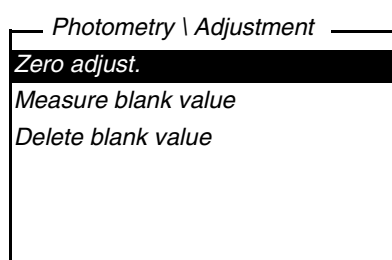

4	Using <▲> <▼> and <START/ENTER>, select and start the <i>Zero adjust.</i> function. The menu-guided zero adjustment starts. Follow the instructions on the display.
---	---

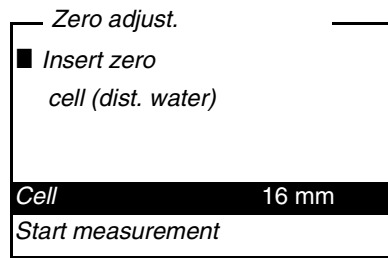

5	Insert the cell (see section 4.2)
6	Set another cell with <▲> <▼> and <START/ENTER> as necessary.
7	<p>Start the measurement of the zero adjustment with <START/ENTER>.</p> <p>After measuring, the result of the zero adjustment is displayed and stored.</p> <ul style="list-style-type: none"> ■ <i>Zero adjust. successful!</i> (successful zero adjustment) or ■ <i>Calibration error!</i> (zero adjustment not successful) <p>is displayed as the result.</p> <p>The zero adjustment is completed.</p>



If ■ *Calibration error!* was displayed as the calibration result, a note automatically reminds you of another zero adjustment before the next measurement.

Measuring is not possible without a valid zero adjustment.

8	<p>Confirm the result with <START/ENTER>.</p> <p>The zero adjustment is completed.</p> <p>The meter is ready to measure.</p>
---	--

4.5.8 Programs

Displaying program data

You can view the most important data of all methods. The method data is ordered according to the program number.

- 1 Open the *Configuration / Photometry / Programs* menu. The display shows the most important data of the selected program.

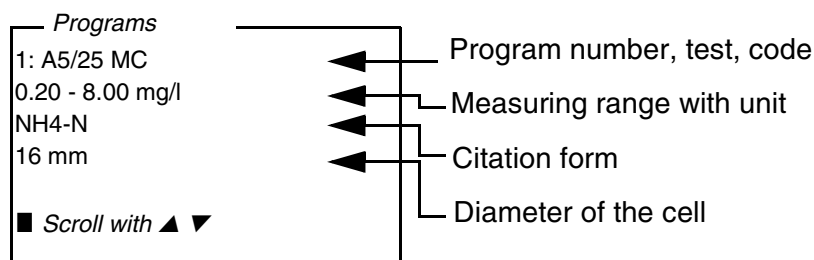

This data is also to be found in the photometry analysis manual in the overview of the test sets and in the individual analysis specifications for the test sets.

Updating programs

Under www.YSI.com on the Internet, you can always find the latest software version with the newest programs and method data for your pHotoFlex® pH (see FIRMWARE UPDATE).

User-defined programs

User-defined programs (methods) can be stored under program numbers between 900 and 999. You can store up to 100 user-defined programs (see section 4.12).

4.5.9 *Analysis timer*

Measuring according to analysis specifications often means there are waiting periods between the individual steps.

These waiting periods (time intervals) are stored in the instrument with the program data for each program. The active *Analysis timer* function automatically reminds you to observe these time intervals by means of the menu guidance.

If you want to manually enter time intervals, use the *Timer* function (see section 4.5.10).

The *Analysis timer* with the required time interval is automatically displayed at the due point.

Start the *Analysis timer* with the **<START/ENTER>** key.

It is not possible to shorten the time interval.

An acoustic signal sounds when the adjusted time interval has expired.

The *Analysis timer* function is switched on or off in the *Configuration / Photometry/Analysis timer* menu.

This setting generally applies to all measurements with methods according to analysis specification.

4.5.10 *Timer*

When measuring according to analysis specifications, waiting periods often have to be kept between individual steps of the method.

With the *Timer* function you manually set a time interval.

If you want to be automatically reminded of the given time interval, use the *Analysis timer* function (see section 4.5.9).

The timer is displayed in the measured value display. It always displays the remaining time of the adjusted time interval.

When the adjusted time interval has expired, the timer indicates 00:00:00 and an acoustic signal sounds.

The *Timer* function is started in the *Configuration / Timer* menu by entering a time interval.

4.5.11 Measuring diluted samples

If the concentration of a test sample exceeds the measuring range of a method, you can dilute the sample by a factor 1 ... 99 so that the concentration of the diluted test sample is within the measuring range of the method (see photometry analysis manual). Thus a valid measurement is possible.

After entering the factor for the dilution the meter converts the concentration to that of the undiluted sample.

The display then indicates the measured value of the undiluted sample.

Entering the factor of the dilution

1	Select the program for which a dilution factor is to be entered.
2	Open the <i>Configuration / Photometry / Dilution</i> menu. The current factor of the dilution is displayed.



3	Open the display for the entry of numerals with <START/ENTER> .
4	Enter the factor of the dilution with the number keys. The factor has to be a whole number between 0 ... 99.
5	Confirm the factor with <START/ENTER> .
6	Exit the <i>Dilution</i> menu with <ESC> . For the following measurements with the selected program, the concentration of the undiluted sampled is displayed as the measurement result.

The entered dilution factor is only valid for the selected program. The dilution factor is erased if:

- the meter is switched off
- a different program number is selected
- the factor 0 is entered in the *Dilution* menu.

If a dilution factor is active, it is indicated on the display during measurement in the form [x + 1].

4.6 pH value / ORP voltage

4.6.1 General information

You can measure the following variables:

- pH value []
- ORP [mV]



Temperature measurement

The RS232 interface is not galvanically isolated. When connecting an earthed PC, measurements cannot be performed in earthed media as incorrect values would result.

For reproducible pH measurements, it is essential to measure the temperature of the test sample.

You have the following possibilities for measuring the temperature:

- Automatic measurement of the temperature by a temperature sensor (NTC30 or Pt1000) integrated in electrode.
- Manual determination and input of the temperature.

The meter recognizes whether a suitable electrode is connected and automatically switches on the temperature measurement.

The display of the temperature indicates the active temperature measuring mode:

Temperature sensor	Resolution of the temp. display	Temperature of the test sample
yes	0.1 °C	automatic measurement
-	1 °C	manual measurement and entry

Preparatory activities

Perform the following preparatory activities when you want to measure:

1	Connect a pH or ORP electrode to the meter.
2	Press the <M> key (long pressure) repeatedly until the <i>pH</i> & <i>ORP</i> measuring mode is selected.
3	Press the <M> key (short pressure) repeatedly until the measured parameter, <i>pH</i> or <i>ORP</i> is selected.
4	Adjust the temperature of the solutions and measure the current temperature if the measurement is made without a temperature sensor.
5	Calibrate or check the meter with the electrode.

4.6.2 Measuring the pH value

- 1 Perform the preparatory activities according to section 4.6.1.
- 2 Immerse the pH electrode in the test sample.

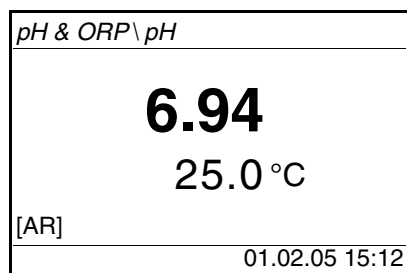

- 3 Press the <M> key (short pressure) repeatedly until the measured variable, *pH* is selected.

AutoRead (Drift control)

The AutoRead function (drift control) continually checks the stability of the measurement signal. The stability has a considerable impact on the reproducibility of measured values. The display of the measured parameter flashes until a stable measured value is available.

Criteria

With identical measurement conditions, the following applies:

Measured parameter	Reproducibility	Response time
pH value	Better than 0.01	> 30 seconds

4.6.3 Measuring the ORP voltage



ORP electrodes are not calibrated. However, you can check ORP electrodes using a test solution.

1	Perform the preparatory activities according to section 4.6.1.
2	Submerge the ORP electrode in the sample.

pH & ORP \ ORP	
157 mV 25.0 °C	
[AR]	01.02.05 15:12

3	Press the <M> key (short pressure) repeatedly until the measured parameter, <i>ORP</i> is selected.
---	---

AutoRead (drift control)

The AutoRead function (drift control) continually checks the stability of the measurement signal. The stability has a considerable impact on the reproducibility of measured values. The display of the measured parameter flashes until a stable measured value is available.

Criteria

With identical measurement conditions, the following applies:

Measured parameter	Reproducibility	Response time
ORP voltage	better than 1 mV	> 30 seconds

4.6.4 Settings for pH and ORP measurements

Overview

For pH and ORP measurements, the following settings are available in the *Configuration / pH & ORP* menu:

- *Measured parameter*
- *Calibration record* (display)
- Selecting the calibration type
- Entering the *Calibration interval*
- Selecting the *Unit for slope*
- Selecting the *Temperature unit*
- *Reset*

Settings/functions

The settings can be found in the *Configuration / pH & ORP* menu. To switch to the *Configuration* menu, press the **<MENU>** key.

Menu item	Possible setting	Description
<i>Measured parameter</i>	<i>pH & ORP</i> mV	
<i>Calibration / Calibration record</i>	-	Displays the calibration record of the last calibration.
<i>Calibration / Cal. type</i>	<i>TEC</i> <i>NIST/DIN</i>	Buffer sets to be used for pH calibration. For details, see section 4.6.5.
<i>Calibration / Calibration interval</i>	1 ... 999 d	<i>Calibration interval</i> for the pH electrode (in days). The meter reminds you to calibrate regularly by the flashing sensor symbol in the measured value display.
<i>Calibration / Unit for slope</i>	mV/pH %	Unit of the slope. The % display refers to the Nernst slope of -59.16 mV/pH (100 x determined slope/Nernst slope).
<i>Man. temperature</i>	-20 ... +130 °C	Entry of the manually determined temperature. For measurements without temperature sensor only.
<i>Temperature unit</i>	°C, °F	Degrees Celsius Degrees Fahrenheit
<i>Reset</i>		Reset all settings for the <i>pH & ORP</i> measuring mode (see section 4.9.3)

4.6.5 Calibration

Why calibrate?

pH electrodes age. This changes the asymmetry (zero point) and slope of the pH electrode. As a result, an inexact measured value is displayed. Calibration determines the current values of the asymmetry and slope of the electrode and stores them in the meter. Thus, you should calibrate at regular intervals.

When to calibrate?

- After connecting another electrode
- When the sensor symbol flashes:
 - after the calibration interval has expired
 - after voltage interruption (e.g. empty batteries, empty rechargeable battery)

Buffer sets for calibration

You can use the buffer sets quoted in the table for an automatic calibration. The pH values are valid for the specified temperature values. The temperature dependence of the pH values is taken into account during calibration.

Buffer set	Name on the display	pH values at 25 °C
YSI technical buffer solutions	<i>TEC</i>	2.00 4.01 7.00 10.01
<i>NIST/DIN</i> buffer solutions	<i>NIST/DIN</i>	1.679 4.006 6.865 9.180 12.454



The buffers are selected in the *Configuration / pH & ORP / Cal. type* menu, see section 4.6.4).

Calibration points

Calibration can be performed using one, two or three buffer solutions in any order (single-point-, two-point or three-point calibration). The meter determines the following values and calculates the calibration line as follows:

	Determined values	Displayed calibration data
1-point	<i>Asy</i>	<ul style="list-style-type: none"> ● Asymmetry = <i>Asy</i> ● Slope = Nernst slope (-59.16 mV/pH at 25 °C)
2-point	<i>Asy</i> <i>Slp.</i>	<ul style="list-style-type: none"> ● Asymmetry = <i>Asy</i> ● Slope = <i>Slp.</i>
3-point	<i>Asy</i> <i>Slp.</i>	<ul style="list-style-type: none"> ● Asymmetry = <i>Asy</i> ● Slope = <i>Slp.</i> <p>The calibration line is calculated by linear regression.</p>



AutoRead

You can display the slope in the unit, mV/pH or % (see section 4.6.4).

The calibration procedure automatically activates the AutoRead function.

The current AutoRead measurement can be terminated at any time (accepting the current value).

Calibration record

When finishing a calibration, the new calibration values are displayed as an informative message (■ symbol) first. Then you can decide whether you want to take over these values of the new calibration or whether you want to continue measuring with the old calibration data. After accepting the new calibration values the calibration record is displayed.

Displaying and downloading calibration data to interface

You can view the data of the last calibration on the display. Subsequently, you can download the displayed calibration data to the interface, e. g. to a PC, with the <PRT> key.

The calibration record of the last calibration can be found under the *Configuration / pH & ORP / Calibration / Calibration record* menu item.





Sample of a record

```

31.10.03 16:13
pHotoFlex Ser. no. 12345678
Calibration pH & ORP
Calibration date 31.10.03 16:13:33
Calibration interval 7 d
AutoCal TEC
Buffer 1 4.01
Buffer 2 7.00
Buffer 3 10.01
Voltage 1 184.0 mV 24.0 °C
Voltage 2 3.0 mV 24.0 °C
Voltage 3 -177.0 mV 24.0 °C
Slope -60.2 mV/pH
Asymmetry 4.0 mV
Sensor +++
    
```

Calibration evaluation

After calibrating, the meter automatically evaluates the calibration. The asymmetry and slope are evaluated separately. The worse evaluation of both is taken into account. The evaluation appears on the display and in the calibration record.

Sample display	Calibration record	Asymmetry [mV]	Slope [mV/pH]
	+++	-15 ... +15	-60.5 ... -58
	++	-20 ... +20	-58 ... -57
	+	-25 ... +25	-61 ... -60.5 or -57 ... -56
	-	-30 ... +30	-62 ... -61 or -56 ... -50
Clean the electrode according to the electrode operating manual			
----	----	< -30 or > 30	... -62 or ... -50
Eliminate the error according to chapter 6 WHAT TO DO IF...			

Preparatory activities

Perform the following preparatory activities when you want to calibrate:

- | | |
|---|--|
| 1 | Connect the pH electrode to the meter.
The pH measured value display is displayed on the screen. |
| 2 | Keep the buffer solutions ready. Adjust the temperature of the buffer solutions, or measure the current temperature if you measure without a temperature sensor. |

4.6.6 Carrying out the TEC and NIST/DIN calibration procedures

The two calibration procedures only differ in the usage of different buffer sets (see section 4.6.5). Make sure the *Cal. type* is correctly set in the *pH & ORP / Calibration* menu (see section 4.6.4).

For this procedure, use any one, two or three YSI technical buffer solutions in ascending or descending order.

The *TEC* calibration is described below. With the *NIST/DIN* calibration, the *NIST/DIN* buffer recognition and different nominal buffer values are displayed. Apart from that, the procedure is identical.



The *TEC* calibration for pH 10.01 is optimized for the YSI technical buffer solution TEP 10 Trace or TPL 10 Trace. Other buffer solutions can lead to an erroneous calibration. The correct buffer solutions are given in the YSI catalog or on the Internet.

- | | |
|---|---|
| 1 | Press the <M> key (short pressure) repeatedly until the measured parameter, <i>pH</i> or <i>ORP</i> is selected. |
| 2 | Start the calibration with <CAL/ZERO> .
The calibration display appears. |

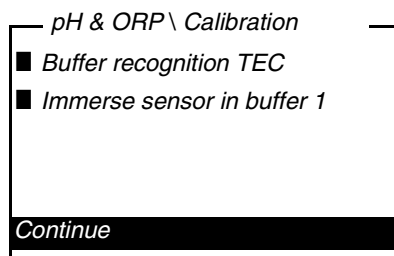

- | | |
|---|---|
| 3 | Immerse the electrode in buffer solution 1. |
| 4 | If the <i>Set temperature</i> menu item appears, measure and enter the temperature of the buffer manually (measurement without temperature sensor). |

- 5 Using **<▲>** **<▼>**, select *Continue* and press **<START/ENTER>**. The buffer is measured.
The measured value is checked for stability (AutoRead).

```

pH & ORP \ Calibration
■ Buffer value = 7.00
■ U = 3 mV
■ Temperature = 24.8 °C
██████████████████
Terminate AutoRead
  
```

- 6 Wait for the end of the AutoRead measurement or accept the calibration value with **<START/ENTER>**.
The calibration display for the next buffer appears.

```

pH & ORP \ Calibration
■ Buffer recognition TEC
■ Immerse sensor in buffer 2

Exit with one point calibration
Continue
  
```

- 7 For single-point calibration, select *Exit with one point calibration* with **<▲>** **<▼>** and confirm with **<START/ENTER>**.
The calibration is completed as a single-point calibration.
The new calibration values are displayed as an informative message (■).
You have the following options:
- Accept the new calibration values with **<START/ENTER>**. Subsequently, the calibration record is displayed and output to the interface at the same time.
 - To switch to the measured value display without accepting the new calibration values, press **<M>** (short pressure) or **<ESC>**.



For **single-point calibration**, the instrument uses the Nernst slope (-59.16 mV/pH at 25 °C) and determines the asymmetry of the electrode.

Continuing for two-point calibration
(*Cal. type TEC*)

8	Thoroughly rinse the electrode with distilled water.
9	Immerse the electrode in buffer solution 2.
10	If the <i>Set temperature</i> menu item appears, measure and enter the temperature of the buffer manually (measurement without temperature sensor).
11	Using <▲> <▼> , select <i>Continue</i> and press <START/ENTER> . The buffer is measured. The measured value is checked for stability (AutoRead).

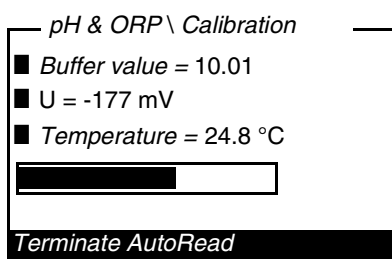

12	Wait for the end of the AutoRead measurement or <i>Terminate AutoRead</i> with <START/ENTER> and take over the calibration value. The calibration display for the next buffer appears.
----	--

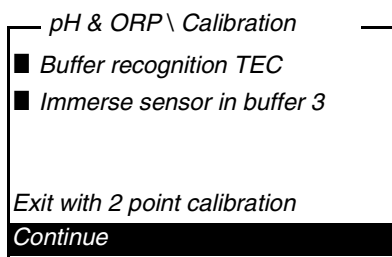

13	For two-point calibration, select <i>Exit with 2 point calibration</i> with <▲> <▼> and confirm with <START/ENTER> . The calibration is completed as a two-point calibration. The new calibration values are displayed as an informative message (■). You have the following options: <ul style="list-style-type: none"> ● Accept the new calibration values with <START/ENTER>. Subsequently, the calibration record is displayed and output to the interface at the same time. ● To switch to the measured value display <u>without</u> accepting the new calibration values, press <M> (short pressure) or <ESC>.
----	---

Continuing for three-point calibration
(*Cal. type TEC*)

14	Thoroughly rinse the electrode with distilled water.
15	Immerse the electrode in buffer solution 3.
16	If necessary, measure the temperature of buffer 3 manually, then enter and confirm it with <▲> <▼> and <START/ENTER> in the <i>Set temperature</i> setting.
17	Using <▲> <▼>, select <i>Continue</i> and press <START/ENTER>. The buffer is measured. The measured value is checked for stability (AutoRead).

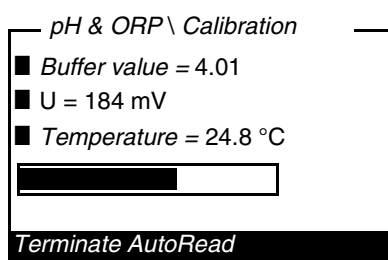

18	<p>Wait for the end of the AutoRead measurement or <i>Terminate AutoRead</i> with <START/ENTER> and take over the calibration value.</p> <p>The new calibration values are displayed as an informative message (■).</p> <p>You have the following options:</p> <ul style="list-style-type: none"> ● Accept the new calibration values with <START/ENTER>. Subsequently, the calibration record is displayed and output to the interface at the same time. ● To switch to the measured value display <u>without</u> accepting the new calibration values, press <M> (short pressure) or <ESC>.
----	---

4.7 Storing

The meter has 1000 storage locations for measurement datasets.

You can transmit measured values (datasets) to the data storage with the <STO> key.

Each storage process transmits the current dataset to the interface at the same time.

The number of storage locations that are still free is displayed in the *Store* menu. The number of storage locations that are occupied is displayed in the *System \ Measured value memory* menu.

Measurement dataset

A complete dataset consists of:

- Date/time
- ID number (ID)
- and the following measurement data depending on the selected measuring mode

Measuring mode	Measurement data
<i>Photometry:</i>	<ul style="list-style-type: none"> ● Program number ● Measured value ● Citation form ● Use of a blank value (BV) ● Dilution (x +1)
<i>pH & ORP:</i>	<ul style="list-style-type: none"> ● Measured value (pH/mV) ● Measured temperature value (°C/°F) ● AutoRead info (AR) <p><i>AR</i> appears with the measured value if the AutoRead criterion was met while storing (stable measured value). Otherwise, the <i>AR</i> display is missing.</p>

4.7.1 Storing measurement datasets

Proceed as follows to transmit to the data storage and simultaneously output to the interface a measurement dataset:

- 1 Press the **<STO>** key.
The *Store* display appears.

```

Store (996 free)S
■ 02.02.2005 11:24:16
  0.00 mg/l PO4-P BV
  PROG 1

ID:                               1
Store (ID: 1:

```

- 2 Using **<▲>** **<▼>**, **<START/ENTER>** and the number keys, change and confirm the ID number (*ID*) as necessary (0 ... 999).
- 3 Using **<START/ENTER>** or **<STO>**, confirm *Store*.
The dataset is stored. The instrument switches to the measured value display.



If the storage is full

A measurement dataset is stored quickly by twice pressing **<STO>**. It is stored with the ID last set.

You can erase the entire storage (see section 4.7.5), or overwrite the oldest dataset with the next storing procedure.

A security prompt appears before a dataset is overwritten.

4.7.2 Filtering measurement datasets

The functions to display and download stored measurement datasets (see section 4.4.1) refer to all stored measurement datasets that correspond to the adjusted filter criteria.

The settings can be found in the *Configuration / System / Measured value memory / Data filter* menu.

To switch to the *Configuration* menu, press the <MENU> key.

Data filter	Menu item	Setting/function	Description
	<i>Filter</i>		Filter criteria:
		<i>No filter</i>	Data filter switched off
		<i>ID</i>	Selection according to ID number
		<i>PROG</i>	Selection according to program
		<i>Date</i>	Selection according to period
		<i>ID + PROG</i>	Selection according to program and ID number
		<i>ID + Date</i>	Selection according to period and ID number
		<i>PROG + Date</i>	Selection according to program and date
		<i>ID + PROG + Date</i>	Selection according to ID, program and date
	<i>ID</i>		Entry of filter criteria
	<i>PROG</i>		These menu items are made visible by selecting the filter criteria in the <i>Filter</i> menu.
	<i>Date</i>		

4.7.3 Displaying measurement datasets

You can read out stored datasets on the display. Only those datasets are displayed that correspond to the selected filter criteria (see section 4.7.2).

Start reading out the data on the display in the menu, *Configuration / System / Measured value memory / Display*.

Display of a dataset

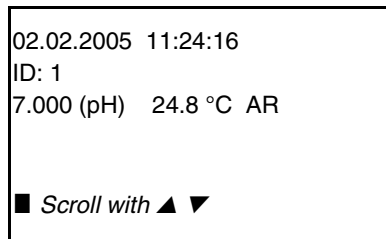

```
02.02.2005 11:24:16
ID: 1
7.000 (pH) 24.8 °C AR
■ Scroll with ▲ ▼
```

Further datasets that correspond to the filter criteria are displayed with the <▲> <▼> keys.

Quitting the display

To quit the display of stored measurement datasets, you have the following options:

- Switch directly to the measured value display with <M> (short pressure).
- Leave the display and switch to the higher menu with <ESC> or <START/ENTER>.

4.7.4 Downloading the measurement datasets to the RS232 interface

You can download stored datasets to the RS232 interface. Only those datasets are downloaded that correspond to the selected filter criteria (see section 4.7.2).

The datasets are downloaded in the adjusted output format (see section 4.8.3).

The data download to the interface is started in the menu, *Configuration / System / Measured value memory / RS232 download*.

4.7.5 Erasing stored measurement datasets

You can erase the stored measurement datasets altogether if you do no longer need them.

Erasing all measurement datasets is done in the menu, *Configuration / System / Measured value memory / Delete*.



Erasing individual datasets is not possible. If all storage locations are occupied, however, it is possible to overwrite the oldest dataset at a time. A security prompt appears before a dataset is overwritten.

4.8 Transmitting data (RS 232 interface)

Via the RS 232 interface, you can transmit data to a PC.

4.8.1 Connecting a PC

Connect the interface to the devices via the AK540/B (PC) cable.



The RS232 interface is not galvanically isolated. When connecting an earthed PC, measurements cannot be performed in earthed media as incorrect values would result.

Set up the following transmission data on the PC:

Baud rate	can be selected from: 1200, 2400, 4800, 9600, 19200 The baud rate must agree with the baud rate set on the PC.
Handshake	RTS/CTS
PC only:	
Parity	none
Data bits	8
Stop bits	1s

Socket assignment

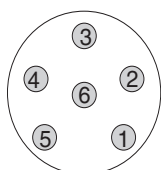

- 1 RTS
- 2 RxD
- 3 TxD
- 4 DTR
- 5 SG
- 6 CTS

RS 232
REC

4.8.2 Configuring the RS232 interface

For an error-free data transmission, the RS232 interface should be set to the same transmission speed (*Baud rate*) on the pHotoFlex® pH and PC.

You can set the following values for the baud rate on the pHotoFlex® pH : 1200, 2400, 4800, 9600, 19200.

The baud rate is selected in the menu, *Configuration / System / Interface / Baud rate*.

4.8.3 Selecting the output format of datasets

For downloading data to the interface you can select the output format.

It is selected in the menu, *Configuration / System / Interface / Output format*.

The ASCII output format delivers formatted datasets.
The CSV output format delivers datasets separated by ";".

Output format, ASCII

```
pHotoFlex Ser. no. 12345678
31.10.04 09:56:20
ID: 1
10.01 (pH) AR
25 °C
-----
pHotoFlex Ser. no. 12345678
31.10.04 15:48:08
ID 1 / PROG 2
1.1 mg/l Pb [BV] [9 + 1]
-----
etc...
```

Output format, CSV

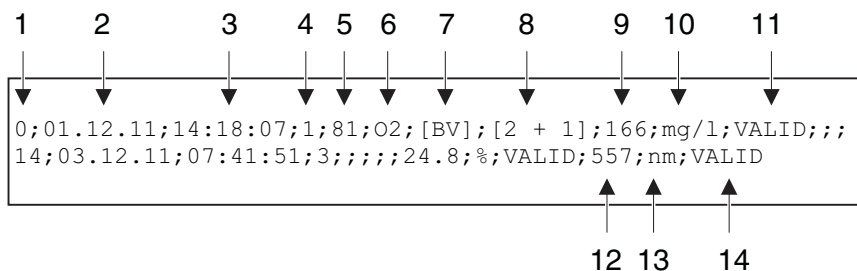

	Data	Description
1	No.	Current number of the storage location (or "0" during output from measured value display)
2	Date	Date of storing
3	Time	Time of storing
4	ID	adjusted ID
5	Program number	Only for the measured parameter, <i>Concentration</i>
6	Citation form	Only for the measured parameter, <i>Concentration</i>
7	AR/ BV	<ul style="list-style-type: none"> ● Measuring mode, <i>pH & ORP</i>: AutoRead ● Measured parameter, <i>Concentration</i>: Blank value
8	Dilution	Only for the measured parameter, <i>Concentration</i>
9	Measured value	<ul style="list-style-type: none"> ● Measured value or ● Upper/lower measuring range limit (only with measured value status, OFL/UFL)
10	Unit of 9	<ul style="list-style-type: none"> ● Unit of the measured value or ● Designation of dimensionless measured values, e.g. <pH>
11	Measured value status of 9	<ul style="list-style-type: none"> ● VALID: Measured value valid ● INVALID: Measured value invalid ● UFL: Measured value below the lower measuring range limit ● OFL: Measured value above the upper measuring range limit
12	Secondary measured value or Standard adjustment	<ul style="list-style-type: none"> ● Measuring mode, <i>pH & ORP</i>: Temperature ● Measured parameter, <i>Absorbance / % Transmission</i>: Wavelength ● for the measured parameter, <i>Concentration</i>: Status standard adjustment [Cal]
13	Unit of 12	<ul style="list-style-type: none"> ● Measuring mode, <i>pH & ORP</i>: °C / °F ● Measured parameter, <i>Absorbance / % Transmission</i>: nm
14	Measured value status of 12	VALID, INVALID, UFL, OFL (see point 11)

4.8.4 Transmitting data

The following table shows which data are transmitted to the interface in which way:

Data	Operation / description
Current measured value	<ul style="list-style-type: none"> ● Press <PRT>. ● Simultaneously with every manual storage process.
Stored measured values	<ul style="list-style-type: none"> ● Display stored dataset and press <PRT>. ● All datasets according to the filter criteria via the <i>RS232 download</i> function (see section 4.7.2).
Calibration record (pH electrode)	<ul style="list-style-type: none"> ● Calibration record of a pH electrode with <PRT> (after calling up from the storage or at the end of a calibration). ● Calibration record of a pH electrode at the end of a calibration procedure is transmitted automatically.



With the <PRT> key you output the data that is being shown on the display to the interface (displayed measured values, stored measurement datasets, calibration record).

4.9 Reset

You can reset (initialize) all system and measurement settings.

4.9.1 Resetting the system settings

With the *System / Reset* function, all resettable settings are reset.

- Settings for *pH & ORP* (see section 4.9.3)
- Settings for *Photometry* (see section 4.9.2)
- System settings

System setting	Default settings
<i>Baud rate</i>	4800 Baud
<i>Output format</i>	ASCII
<i>Illumination</i>	<i>Auto off</i>
<i>Contrast</i>	50 %
<i>Brightness</i>	50 %
<i>Switchoff time</i>	30 min
<i>Beep</i>	<i>On</i>
Measuring mode	<i>Photometry</i>

4.9.2 Resetting the photometry settings

With the *Photometry / Reset* function, all photometry settings are reset.

Setting	Default settings
<i>PROG</i>	0
Cell size	16 mm
<i>Measured parameter</i>	<i>Concentration</i>
Wavelength	436 nm
Blank values	all erased

4.9.3 Resetting the pH settings



The calibration data are reset to the default settings together with the measuring parameters. Recalibrate after performing a reset.

The following settings for pH measurements are reset to the default settings with the *Reset* function:

Setting	Default settings
<i>Cal. type</i>	<i>TEC</i>
<i>Calibration interval</i>	7 d
<i>Measured parameter</i>	<i>pH & ORP</i>
Asymmetry (<i>Asy</i>)	0 mV
Slope (<i>Slp.</i>)	-59.16 mV/pH
Temperature, manual	25 °C
Temperature	°C

4.10 Meter information

The following meter information is listed in the *Configuration / Info* menu:

- Model designation
- Software version
- Version number(s) of the stored program data
- Series number of the meter

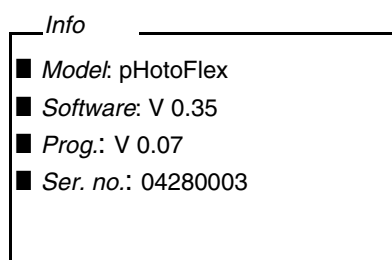

4.11 Software update

With a software update you obtain the current software with all new programs and method data (see section 11).

A software update comprises

- new instrument software
- new programs (methods)
- revisions of existing methods

The current software version can be found on the Internet under www.YSI.com.

The proceeding for updating the software can be found in the appendix (see section 11).

4.12 Administrating user-defined methods

User-defined programs can be

- entered
- read out
- erased.

To store user-defined programs (methods) in the meter, determine a calibration line for your method yourself and transmit the data of this calibration line to the pHotoFlex® pH.

Administration of the method data can be carried out in the LSdata software (see operating manual LSdata) or with the aid of a terminal program (section 4.12.1).

You need the following data in any case:

Data	Possible entries/examples
<i>Program No:</i>	900 ... 999
<i>Model:</i>	Any name (max. 5 characters)
<i>Cuvette [mm]:</i>	16 or 28
<i>Wave length [nm]:</i>	436, 517, 557, 594, 610 or 690
<i>MRB:</i> (measuring range beginning)	e.g. 0.05
<i>MRE:</i> (measuring range end)	e.g. 8.00
<i>E0: (Offset)</i>	e.g. 0.0
<i>Slope:</i>	e.g. 1.0
<i>Resolution:</i>	0.0001, 0.001, 0.01, 0.1, 1, 2, 5, 10 or 100
<i>Formula: (citation form)</i>	e.g. PO4-P (max. 9 characters)
<i>Unit</i>	e.g. mg/l (max. 7 characters)
<i>Blank required:</i> (No/Yes)	0 or 1
<i>Standard adjustment possible:</i> (No/Yes)	0 or 1
<i>Standard adjustment required:</i> (No/Yes)	0 or 1

4.12.1 Administrating user-defined programs with a terminal program

Generally, a terminal program serves to establish a connection to a device on a data interface and to communicate with the device via a console on the display.

Thus, it is also possible to send command lines.

Terminal programs are available for different operating systems by different manufacturers. Windows (version 95 to XP) contains the "HyperTerminal" terminal program. It is in the program menu under *accessories*.

For more detailed information please refer to the user information of the terminal program.



The CD-ROM contains a configuration file for the HyperTerminal program. By double-clicking the configuration file (*.ht), the HyperTerminal with the required pre-settings for data exchange with the meter is opened.

The pHotoFlex® pH can administrate the database of user-defined programs via command lines.

1	With the aid of the AK 540/B interface cable, connect the pHotoFlex® pH 540 to the serial interface (COM port) of the PC (see section 8.1.1).
2	Make sure the pHotoFlex® pH is switched on.
3	Start the terminal program on the PC.
4	Configure the connection settings for the COM interface as necessary.

Storing user-defined programs

Enter a command line according to the following scheme in the terminal program:

U.500#14, Program No, Model, Cell [mm], Wave length [nm], MRB, MRE, E0, Slope, Resolution, Citation form, Unit, Blank required, Standard adjustment possible, Standard adjustment required

Example:

U.500#14, 900, Test, 16, 436, 0.0, 2.0, 0.0, 1.0, 0.01, test, mg/l, 0, 1, 0

The individual data sections of the command line are separated by commas. The dot "." has to be used as a decimal separator within a data section.

5	Enter the command line.
6	Finish the command line with Enter. The data is transmitted to the pHotoFlex® pH.



If a program is already stored under the selected number, the programming procedure is canceled. To store the program under the selected number, first erase the program stored under the number.

After successful transmission, the terminal program writes "!>". If the transmission failed, the terminal program writes "!>".

Erasing user-defined programs

To erase user-defined programs, enter a command line according to the following scheme in the terminal program:

	Erase all user-defined programs	Erase one user-defined program
Command line	U.520	U.521#1, Program No
Example	U.520	U.521#1, 900

7	Enter the command line.
8	Finish the command line with Enter. The data is transmitted to the pHotoFlex® pH. The requested data is displayed on the terminal as the result.

After successful transmission, the requested data is displayed on the terminal.

If the transmission failed, the terminal program writes "!>".

Reading out user-defined programs

To read out user-defined programs, enter a command line according to the following scheme in the terminal program:

	Read out all user-defined programs	Read out one user-defined program
Command line	U.510	U.511#1, <i>Program No</i>
Example	U.510	U.511#1,900

9	Enter the command line.
10	Finish the command line with Enter. The data is transmitted to the pHotoFlex® pH. The requested data is displayed on the terminal as the result.

After successful transmission, the terminal program writes "!>".
If the transmission failed, the terminal program writes "!>".

5 Maintenance, cleaning, disposal

5.1 Maintenance

The meter is almost maintenance-free.
The only maintenance task is replacing the batteries or rechargeable battery.

5.1.1 Inserting/exchanging the batteries

NOTE

Make sure that the poles of the batteries are positioned correctly.
The ± signs on the batteries must correspond to the ± signs in the battery compartment.

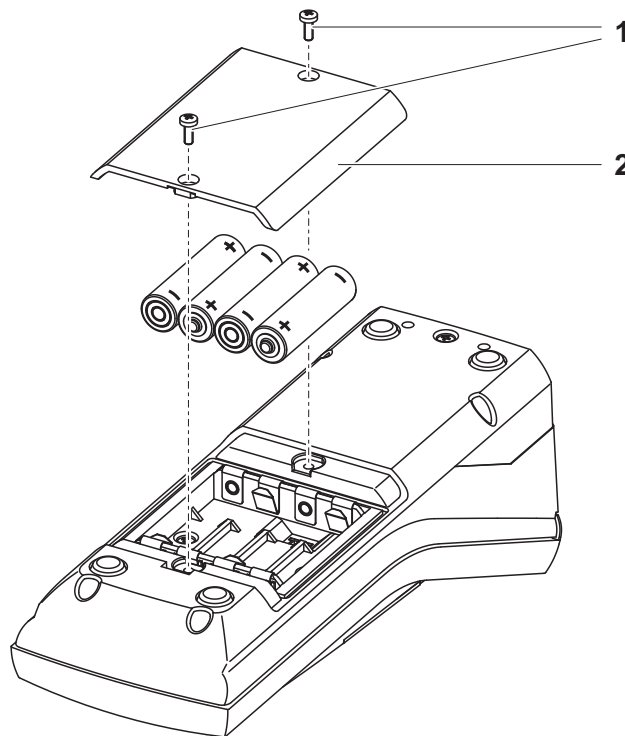

- | | |
|---|--|
| 1 | Open the battery compartment: <ul style="list-style-type: none">– Unscrew the two screws (1) on the underside of the meter,– Remove the lid of the battery compartment (2). |
| 2 | If necessary, take four old batteries out of the battery compartment. |
| 3 | Insert four batteries (3) in the battery compartment. |
| 4 | Close the battery compartment and fix it with the screws. |



Dispose of used batteries according to the local regulations of your country.

End users within the European Union are obligated to return used batteries (even ecologically compatible ones) to a collection point set up for recycling purposes.

Batteries are marked with the crossed-out waste container symbol. Therefore, they may not be disposed with the domestic waste.

5.1.2 Retrofitting the rechargeable battery

NOTE

Use original YSI rechargeable battery only.

Together with the power pack the rechargeable battery is available as an accessory (see section 8.1).

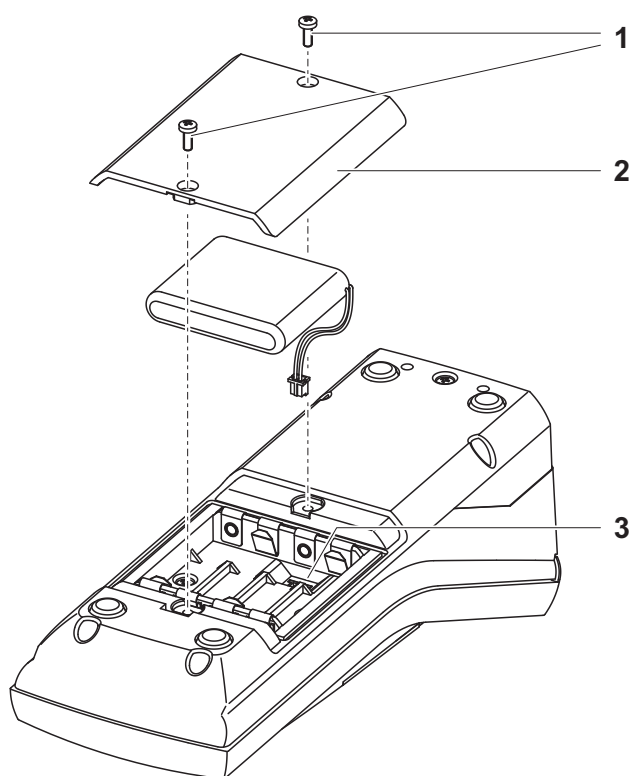

- 1 Open the battery compartment:
 - Unscrew the two screws (1) on the underside of the meter,
 - Remove the lid of the battery compartment (2).

- | | |
|---|--|
| 2 | If necessary, take four old batteries out of the battery compartment. |
| 3 | Connect the cable of the rechargeable battery with the socket (3) on the bottom of the battery compartment and insert the rechargeable battery in the battery compartment. |
| 4 | Close the battery compartment and fix it with the screws. |



Dispose of used batteries according to the local regulations of your country.

End users within the European Union are obligated to return used batteries (even ecologically compatible ones) to a collection point set up for recycling purposes.

Batteries are marked with the crossed-out waste container symbol. Therefore, they may not be disposed with the domestic waste.

5.2 Cleaning

Occasionally wipe the outside of the measuring instrument with a damp, lint-free cloth. Disinfect the housing with isopropanol as required.

NOTE

The housing parts are made of plastic (polyurethane, ABS and PMMA) and are only conditionally resistant against organic solvents. Thus, avoid contact with acetone and similar detergents that contain solvents. Remove any splashes immediately.

5.2.1 Cleaning the cell shaft

If liquid is in the cell shaft (e.g. due to a spilled cell), clean the cell shaft as follows:



CAUTION

Cells can contain poisonous or corrosive substances. If the content is released follow the danger warnings on the cell. If necessary, take corresponding protective measures (protective goggles, protective gloves etc.).

- | | |
|---|---|
| 1 | Switch the pHotoFlex® pH off and pull out the power plug. |
| 2 | Rinse the cell shaft with distilled water. |

5.2.2 Cleaning the cells

Cells have to be clean, dry, and free of fingerprints. Therefore, clean them regularly:

1	Clean the cells inside and out with hydrochloric acid or laboratory soap.
2	Rinse out several times with distilled water.
3	Let them dry in the air.
4	Only hold the cells by the top or by the light protection cap so that the optical path is not impaired.
5	Before measuring, clean the cell with the enclosed cleaning cloth.

5.3 Packing

This meter is sent out in a protective transport packing.



We recommend: Keep the packing material. The original packing protects the meter against damage during transport.

5.4 Disposal

Batteries

Dispose of used batteries according to the local regulations of your country (see section 5.1.1).

Meter

At the end of its operational lifetime, the meter must be returned to the disposal or return system statutory in your country. If you have any questions, please contact your supplier.

6 What to do if...

6.1 General errors

Display, LoBat	Cause	Remedy
	<ul style="list-style-type: none"> – The batteries or rechargeable battery are largely depleted 	<ul style="list-style-type: none"> – Insert new batteries – Charge the rechargeable battery (see section 3.2)
Instrument does not react to keystroke	Cause	Remedy
	<ul style="list-style-type: none"> – Software error – Operating condition undefined or EMC load unallowed 	<ul style="list-style-type: none"> – Processor reset: Press the <START/ENTER> and <PRT> key simultaneously.
RS232 interface does not react	Cause	Remedy
	<ul style="list-style-type: none"> – Software error – Operating condition undefined or EMC load unallowed 	<ul style="list-style-type: none"> – Processor reset: Press the <START/ENTER> and <PRT> key simultaneously.
Error message, <i>Error</i> 0, 8, 16, 16384	Cause	Remedy
	<ul style="list-style-type: none"> – Instrument error 	<ul style="list-style-type: none"> – Repeat measurement – Meter defective, send meter to YSI for repair and quote the error number

6.2 Photometry

Measuring range undercut or exceeded

Cause	Remedy
– Program not suitable	– Select program with suitable measuring range – Dilute the sample

Obviously incorrect measured values

Cause	Remedy
– Measurement disturbed by external light	– Close the external light cover.
– Cell not correctly inserted	– Insert the cell so that it is positioned on the bottom of the cell shaft.
– Cell contaminated	– Clean the cell
– Cell shaft contaminated	– Clean the cell shaft
– Dilution set incorrectly	– Set the dilution
– Selected program unsuitable	– Select other program
– Zero measurement incorrect	– Perform zero measurement
– Blank value incorrect	– Remeasure the blank value

6.3 pH value / ORP voltage

Measuring range undercut or exceeded

Cause	Remedy
<i>Electrode:</i>	
– Air bubble in front of the diaphragm	– Remove air bubble
– Air in the diaphragm	– Extract air or moisten diaphragm
– Gel electrolyte dried out	– Replace electrode
<i>Test sample</i>	
– The pH value lies outside the measuring range	– not possible

Measured value display

(calibration error)

Cause	Remedy
<i>Electrode:</i>	
– Diaphragm contaminated	– Clean diaphragm
– Membrane contaminated	– Clean membrane
– Moisture in the plug	– Dry plug
– Not enough electrolyte	– Top up electrolyte
– Electrode obsolete	– Replace electrode
– Electrode broken	– Replace electrode
– Socket damp	– Dry socket
<i>Calibration procedure:</i>	
– Incorrect solution temperature (without temperature sensor)	– Set up correct temperature
– Incorrect buffer solutions	– Select buffer solutions suitable for the calibration procedure
– Buffer solutions too old	– Use only once. Note the shelf life

No stable measured value

Cause	Remedy
<i>pH electrode:</i>	
– Diaphragm contaminated	– Clean diaphragm
– Membrane contaminated	– Clean membrane
<i>Test sample</i>	
– pH value not stable	– Measure with air excluded if necessary
– Temperature not stable	– Temper if necessary
<i>Electrode + test sample:</i>	
– Conductivity too low (e.g. in ultrapure water)	– Use suitable electrode
– Temperature too high	– Use suitable electrode
– Organic liquids	– Use suitable electrode

Obviously incorrect measured values

Cause	Remedy
<i>pH electrode:</i>	
– Not connected	– Connect electrode
– Cable broken	– Replace cable or electrode
– pH electrode unsuitable	– Use suitable electrode
– Temperature difference between buffer and test sample too high	– Adjust temperature of buffer or sample solutions
– Measurement procedure not suitable	– Follow special procedure

Sensor symbol flashes

Cause	Remedy
– Calibration interval expired	– Recalibrate the measuring system

7 Technical data

7.1 General data

Dimensions	approx. 236 x 86 x 117 mm	
Weight	approx. 0.6 kg (without batteries)	
Mechanical structure	Type of protection	IP 67
Electrical safety	Protective class	III
Test certificates	cETLus, CE, FCC	
Ambient conditions	Storage	- 25 °C ... + 65 °C
	Operation	0 °C ... + 50 °C
	Climatic class	2
Allowable relative humidity	Yearly mean:	75 %
	30 days /year:	95 %
	other days:	85%
Power supply	Batteries	4 x 1.5 V, type AA
	Operating time with battery operation	approx. 5000 measurements
	Rechargeable battery (optional)	5 x 1.2 V nickel metal hydride (NiMH), type AAA
	Power pack Charging device (optional)	FRIWO FW7555M/09, 15.1432.500-00 Friwo Part. No. 1883259 Input: 100 ... 240 V ~ / 50 ... 60 Hz / 400 mA Output: 9 V = / 1,5 A Connection max. overvoltage category II Primary plugs contained in the scope of delivery: Euro, US, UK and Australian.
Serial interface	Connection of the cable AK 540/B or AK 540/S	
	Baud rate	adjustable: 1200, 2400, 4800, 9600, 19200 Baud
	Type	RS232
	Data bits	8
	Stop bits	2
	Parity	None
	Handshake	RTS/CTS
	Cable length	max. 15 m

Guidelines and norms used	EMC	EC guideline 89/336/EEC EN 61326-1/A3:2003 FCC Class A
	Instrument safety	EEC guideline 73/23/EEC EN 61010-1 :2001 UL3101-1 CAN/CSA-C22.2 No. 1010.1-92
	Climatic class	VDI/VDE 3540
	IP protection	EN 60529:1991

FCC Class A Equipment Statement

Note: This equipment has been tested and found to comply with the limits for a Class A digital device, pursuant to Part 15 of the FCC Rules. These limits are designed to provide reasonable protection against harmful interference when the equipment is operated in a commercial environment. This equipment generates, uses, and can radiate radio frequency energy and, if not installed and used in accordance with the instruction manual, may cause harmful interference to radio communications. Operation of this equipment in a residential area is likely to cause harmful interference in which case the user will be required to correct the interference at his own expense.

7.2 Photometry

Optical measuring principle	LED photometer with filter	
Interference filter	436 nm, 517 nm, 557 nm, 594 nm, 610 nm, 690 nm	
	Accuracy:	± 2 nm
Photometric reproducibility	0.005 or better	
Photometric resolution	0.001	
Warm-up time	none	
Measuring time	approx. 2s	
Measured parameters	Concentration (method dependent, selectable display form), absorbance, transmission	
Measuring range	Absorbance:	-0.200 ... +2.000
	Transmission:	1 ... 150 %
User-defined programs	100	
Resolution	1.00 ... 9.99	0,01 %
Transmission	10.0 ... 150	± 0.1

7.3 pH value / ORP voltage

Measuring ranges, resolution

Variable	Measuring range	Resolution
pH	- 2.00 ... + 16.00	0.01
U [mV]	- 1000 ... + 1000	1
T [°C]	- 5.0 ... + 100.0	0.1
T [°F]	- 23.0 ... + 212.0	0.1

Manual temperature input

Variable	Range	Increment
T _{manual} [°C]	- 20 ... + 100	1

Accuracy (± 1 digit)

Variable	Accuracy	Temperature of the test sample
pH *	± 0.01	+ 15 °C ... + 35 °C
U [mV]	± 1	+ 15 °C ... + 35 °C
T [°C]	± 0.3	0 °C ... + 55 °C
T [°F]	± 0.54	0 °C ... + 55 °C

* when measuring in a range of ± 2 pH around a calibration point

8 Accessories, options

8.1 Accessories

Description	Model	Order no.
LabStation with LSdata PC software, rechargeable battery and universal power pack	LS Flex/430	251 301Y
Rechargeable battery for pHotoFlex	RB Flex/430	251 300Y

8.1.1 Connection cable

PC You can connect a PC to the pHotoFlex® pH in one of the following ways:

Description	Model	Order no.
● Connection PC - pHotoFlex® pH		
– Cable	AK 540/B	902 842Y
+ USB adapter (for USB connection on PC)	Ada USB	902 881Y
● Connection PC - LabStation		
– Zero modem cable	AK Labor	902 758Y
+ USB adapter (for USB connection on PC)	Ada USB	902 881Y

8.2 Optional extensions of the pHotoFlex® pH

The following optional extensions are available in specialist shops:

Device/cable	Model
Barcode reader*	<ul style="list-style-type: none"> ● Handscanner Datalogic DLC6065-M1 ● Handscanner Datalogic Touch65
Connection cable Barcode reader - LabStation	Datalogic CAB-350

* In addition to the barcode reader, a suitable connection cable is required to operate the barcode reader

9 Lists

This chapter provides additional information and orientation aids.

Abbreviations

The list of abbreviations explains the indicators and the abbreviations that appear on the display and in the manual.

Specialist terms

The glossary briefly explains the meaning of the specialist terms. However, terms that should already be familiar to the target group are not described here.

Abbreviations

°C	Temperature unit, degrees Celsius
°F	Temperature unit, degrees Fahrenheit
Asy	Asymmetry
Cal	Calibration
d	Day
h	Hour
j	Year
K	Temperature unit, Kelvin
LoBat	Batteries almost empty (Low battery)
m	Month
mV	Voltage unit
mV/pH	Unit of the electrode slope (internat. mV)
<i>NIST/DIN</i>	Automatic pH calibration with buffer solutions prepared according to NIST or DIN 19266
pH	pH value
s	Second
S	Slope (internat. k)
SELV	Safety Extra Low Voltage
<i>Slp.</i>	Slope determined with calibration
<i>TEC</i>	Automatic pH calibration with YSI technical buffer solutions according to DIN 19267
U	Voltage

Glossary

Adjusting	To manipulate a measuring system so that the relevant value (e. g. the displayed value) differs as little as possible from the correct value or a value that is regarded as correct, or that the difference remains within the tolerance.
Asymmetry	Designation for the offset potential of a pH electrode. It is the measurable potential of a symmetrical electrode, the membrane of which is immersed in a solution with the pH of the nominal electrode zero point (YSI electrodes: pH = 7).
AutoRange	Name of the automatic selection of the measuring range.
AutoRead	YSI name for a function to check the stability of the measured value.
Calibration	Comparing the value from a measuring system (e. g. the displayed value) to the correct value or a value that is regarded as correct. Often, this expression is also used when the measuring system is adjusted at the same time (see adjusting).
Electrode zero point	The zero point of a pH electrode is the pH value at which the electromotive force of the pH electrode at a specified temperature is zero. Normally, this is at 25 °C.
Electromotive force of an electrode	The electromotive force U of the electrode is the measurable electromotive force of an electrode in a solution. It equals the sum of all the galvanic voltages of the electrode. Its dependency on the pH results in the electrode function which is characterized by the parameters, slope and zero point.
Junction	The junction is a porous body in the housing wall of reference electrodes or electrolyte bridges. It forms the electrical contact between two solutions and makes electrolyte exchange more difficult. The expression, junction, is also used for ground or junction-less transitions.
Measured parameter	The measured parameter is the physical dimension determined by measuring, e. g. pH, conductivity or DO concentration.
Measured value	The measured value is the special value of a measured parameter to be determined. It is given as a combination of the numerical value and unit (e. g. 3 m; 0.5 s; 5.2 A; 373.15 K).
Measuring system	The measuring system comprises all the devices used for measuring, e. g. meter and sensor. In addition, there is the cable and possibly an amplifier, terminal strip and armature.
Molality	Molality is the quantity (in Mol) of a dissolved substance in 1000 g solvent.
MultiCal®	YSI name stating that a meter provides several pH calibration procedures.

Offset potential	The measurable potential of a symmetrical electrode, the membrane of which is immersed in a solution with the pH of the nominal electrode zero point. The asymmetry is part of the offset potential.
ORP voltage	The ORP is caused by oxidizing or reducing substances dissolved in water if these substances become effective on an electrode surface (e. g. a gold or platinum surface).
pH value	The pH value is a measure of the acidic or basic effect of an aqueous solution. It corresponds to the negative decadic logarithm of the molal hydrogen ions activity divided by the unit of the molality. The practical pH value is the value of a pH measurement.
Potentiometry	Name of a measuring technique. The signal (depending on the measured parameter) of the electrode is the electrical potential. The electrical current remains constant.
Reset	Restoring the original condition of all settings of a measuring system.
Resolution	Smallest difference between two measured values that can be displayed by a meter.
Slope	The slope of a linear calibration function.
Standard solution	The standard solution is a solution where the measured value is known by definition. It is used to calibrate a measuring system.
Temperature function	Name of a mathematical function expressing the temperature behavior of a test sample, a sensor or part of a sensor.
Test sample	Designation of the test sample ready to be measured. Normally, a test sample is made by processing the original sample. The test sample and original sample are identical if the test sample was not processed.

Analysis specification	The exact proceeding to carry out the detection procedure is described in the analysis specification.
Blank value (reagent blank value)	The evaluation of the photometric measurement always refers to the comparison value of a sample without the substance to be determined (reagent blank value). Thus the influence of the basic absorbance of the reagents on photometric measurement is compensated for.
Cell	Vessel to take a liquid sample for photometric measurements. The cell material (mostly glass) must have certain optical features to be suitable for photometry.
Citation forms	Different forms of representing a measured concentration value that can be derived from each other. The method to determine phosphate, e.g. delivers a measured value for phosphorous P. This measured value can be alternatively quoted in the citation forms, PO ₄ , PO ₄ -P or P ₂ O ₅ .
Detection procedure	The detection procedure designates the general principle of how a sample is brought into a form suitable for measurement. Different methods can be based on the same detection procedure.
LED	Light Emitting Diode LEDs are used as the light source in the pHotoFlex® pH.
Method	A method comprises a chemical detection procedure and special method data (calibration line) that is required to evaluate the measurement results. How to carry out the method up to the photometric measurement is described in the analysis specification. The pHotoFlex® pH contains a database with methods (programs). Furthermore, user-defined methods can be entered in the database as well.
Program	In the pHotoFlex® pH, methods with the relevant method data are stored as programs. Programs are called up via the assigned program number.
Test set (test)	A test set contains all reagents that are required for the photometric determination of the sample according to the analysis specification.
Zero adjustment	Adjusting a photometer with a water-filled cell. The zero adjustment applies to measuring all measured parameters (concentration, absorbance, transmission) of a photometer.

10 Index

A

Analysis specification	35
Analysis timer	47
Asymmetry of the pH electrode	53
Automatic switchoff	16, 19
AutoRead	
ORP	51
pH	50

B

Blank value	38
Blank value measurement	39
Buffer sets, pH	53

C

Calibration	
pH	53
Calibration points	
pH	54
Cell	
insert	20
Cleaning	79
Concentration measurement	37
Connecting a sensor	10

D

Data filter	62
Dataset	60
Date and time	25
Date/time	34
Delivery condition	
measuring parameters	69
system settings	68, 69
Diluted samples	
measuring	48
Display	10, 33
Display illumination	10, 20
Drift control	
ORP	51
pH	50

F

Filter	62
Firmware update	99

I

Initial commissioning	18
Initialization	68
Interface	33

K

Key functions	8
Keys	8

M

Measured value display	22
Measurement dataset	60
Measuring	
ORP voltage	51
pH	50
Measuring menu	
pH/ORP	32, 52
Measuring the absorbance/transmission ...	43
Memory	31
Menus (navigation)	23
Messages	24
Method	35

N

Navigation	22
------------------	----

O

Operating modes	22
-----------------------	----

P

pH calibration evaluation	55
Photometric determinations	35
Power pack	15
Program	35
Programs	46

R

Rechargeable battery	
charging time	15
Reset	68
RS232 socket assignment	64

S

Safety	13
Scope of delivery	15
Single-point calibration	
pH	57
Slope	
pH	53
Socket field	10
Storage of measured values	
storage locations	60
Storing	60
Switching on	19
System menu	
General	33
general information	36
System settings	30
general	30, 33, 34

T

Temperature measurement	
pH	49
Test set	35
Three-point calibration	
pH	59
Timer	47
Transmitting data	64
Transmitting measured values	64
Two-point calibration	
pH	58

U

User-defined programs	46
-----------------------------	----

Z

Zero adjustment	44
-----------------------	----

11 Firmware update

General information

You can update the firmware of the pHotoFlex® pH to the latest version with the aid of a Personal Computer.

You can find available firmware update files for your meter on the Internet.

The update program contains:

- the newest firmware (meter software)
- new or changed method data and programs.

A free serial interface (COM port) on your PC and the AK 540/B interface cable is required for this.

Connecting the meter to the PC

The following is required for connection to a PC:

- a free serial interface (COM or USB port) on your PC
- cable or LabStation with cable for connection to PC
 - for direct connection of the meter to the PC: the AK 540/B interface cable (accessory) or
 - for connection with the LabStation: an operable LabStation with null modem cable (accessory, see section 8.1)
- for connection to a USB interface on the PC: a USB adapter (accessory).

Program installation

Install the firmware update program on your PC.

For Microsoft Windows 7, administrator rights are required.

Program start

Start the program from the Windows start menu.

Via the language menu you can change the adjusted language.

For Microsoft Windows 7, administrator rights are required.

Firmware update

Proceed as follows:

- | | |
|---|---|
| 1 | Connect the pHotoFlex® pH to an interface of the PC. |
| 2 | Make sure the pHotoFlex® pH is switched on. |
| 3 | To start the updating process click the OK button. |
| 4 | Then follow the instructions of the program.
The programming procedure takes approx. 5 minutes.
A final message appears after the successful programming procedure. The firmware update is completed with this. |

- 5 | Disconnect the meter from the PC.
The instrument is ready for operation.

After switching the meter off and on again you can check on the start display whether the meter has taken over the new software version.

12 Contact Information

12.1 Ordering & Technical Support

Telephone: (800) 897-4151
(937) 767-7241
Monday through Friday, 8:00 AM to 5:00 PM ET

Fax: (937) 767-1058

Email: environmental@ysi.com

Mail: YSI Incorporated
1725 Brannum Lane
Yellow Springs, OH 45387
USA

Internet: www.ysi.com

When placing an order please have the following information available:

YSI account number (if available)	Name and Phone Number
Model number or brief description	Billing and shipping address
Quantity	Purchase Order or Credit Card

12.2 Service Information

YSI has authorized service centers throughout the United States and Internationally. For the nearest service center information, please visit www.ysi.com and click 'Support' or contact YSI Technical Support directly at 800-897-4151.

When returning a product for service, include the Product Return form with cleaning certification. The form must be completely filled out for an YSI Service Center to accept the instrument for service. The Product Return form may be downloaded at www.ysi.com and clicking on the 'Support' tab.

Xylem ['zīləm]

- 1) The tissue in plants that brings water upward from the roots;
- 2) a leading global water technology company.

We're 12,500 people unified in a common purpose: creating innovative solutions to meet our world's water needs. Developing new technologies that will improve the way water is used, conserved, and re-used in the future is central to our work. We move, treat, analyze, and return water to the environment, and we help people use water efficiently, in their homes, buildings, factories and farms. In more than 150 countries, we have strong, long-standing relationships with customers who know us for our powerful combination of leading product brands and applications expertise, backed by a legacy of innovation.

For more information on how Xylem can help you, go to www.xyleminc.com



a **xylem** brand

YSI
1725 Brannum Lane
Yellow Springs, OH 45387
Tel: +1 937-767-7241; 800-765-4974
Fax: +1 937-767-1058
Email: environmental@ysi.com
Web: www.ysi.com

©Xylem Inc